

Mercury II™ 6000 & 6000V

Installation Manual and Reference Guide

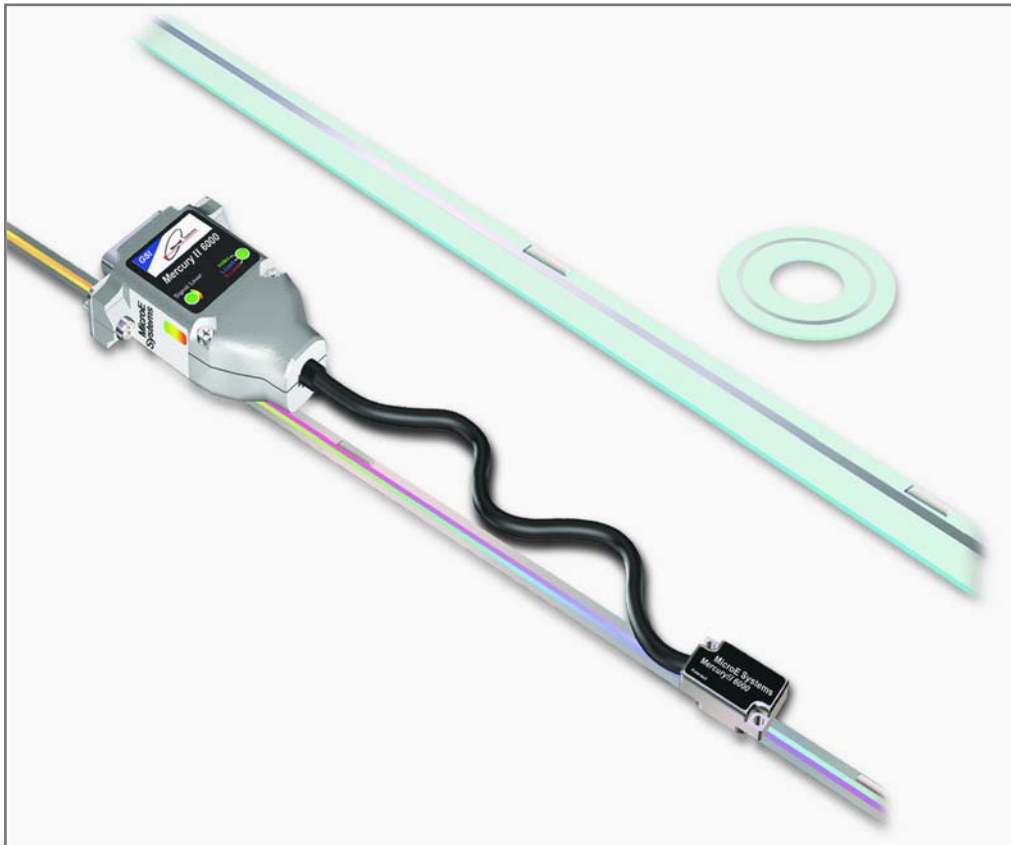

MicroE Systems - World Headquarters: 125 Middlesex Turnpike, Bedford, MA USA 01730-1409

Introduction

MicroE Systems was founded to advance encoder technology to a level never before achieved. Our objective was to design encoder systems that would be small enough to fit into densely packed OEM equipment designs, affordable enough for cost-sensitive applications and easy enough to enable installation, setup and alignment by assemblers with little training. We are pleased to say that all of these goals have been realized with the introduction of the original Mercury™ family of encoder systems. Now, the Mercury II series offers all of that plus improved performance, ease of use and versatility.

Precautions



- 1 Follow standard ESD precautions. Turn power off before connecting the sensor. Do not touch the electrical pins without static protection such as a grounded wrist strap.
- 2 Do not touch the glass scale unless you are wearing talc-free gloves or finger cots. Please read this installation manual for full instructions.

LASER SAFETY INFORMATION: Mercury & ChipEncoder

This product is sold solely for use as a component (or replacement) in an electronic product; therefore it is not required to, and does not comply with, 21 CFR 1040.10 and 1040.11 which pertain to complete laser products. The manufacturer of the complete system-level electronic product is responsible for complying with 21 CFR 1040.10 and 1040.11 and for providing the user with all necessary safety warnings and information.

MicroE encoders contain an infrared laser diode or diodes. Emitted invisible laser radiation levels have been measured to be within the CDRH Class 1 range, which is not considered hazardous; however, to minimize exposure to the diverging beam, the encoder sensor should be installed in its operational configuration in close proximity to the encoder scale before power is applied.



- Invisible laser radiation; wavelength: 850 nm
- Max power 2.4 mW CW (4.8 mW CW for Mercury II™)
- CAUTION – The use of optical instruments with this product will increase eye hazard. DO NOT VIEW DIRECTLY WITH OPTICAL INSTRUMENTS (MICROSCOPES, EYE LOUPES OR MAGNIFIERS).
- All maintenance procedures such as cleaning must be performed with the MicroE encoder turned off.
- Do not insert any reflective surface into the beam path when the encoder is powered.
- Do not attempt to service the MicroE encoder.

Patents

Covered by the following patents: US 5,991,249; EP 895,239; JP 3,025,237; US 6,897,435; and EP 1,451,933. Additional patents and patents pending may apply.

 Mercury II models are CE and RoHS compliant.

System Overview

Encoder with PurePrecision™ Tape or Glass Scales

A1.0 Mercury II™ 6000 System View

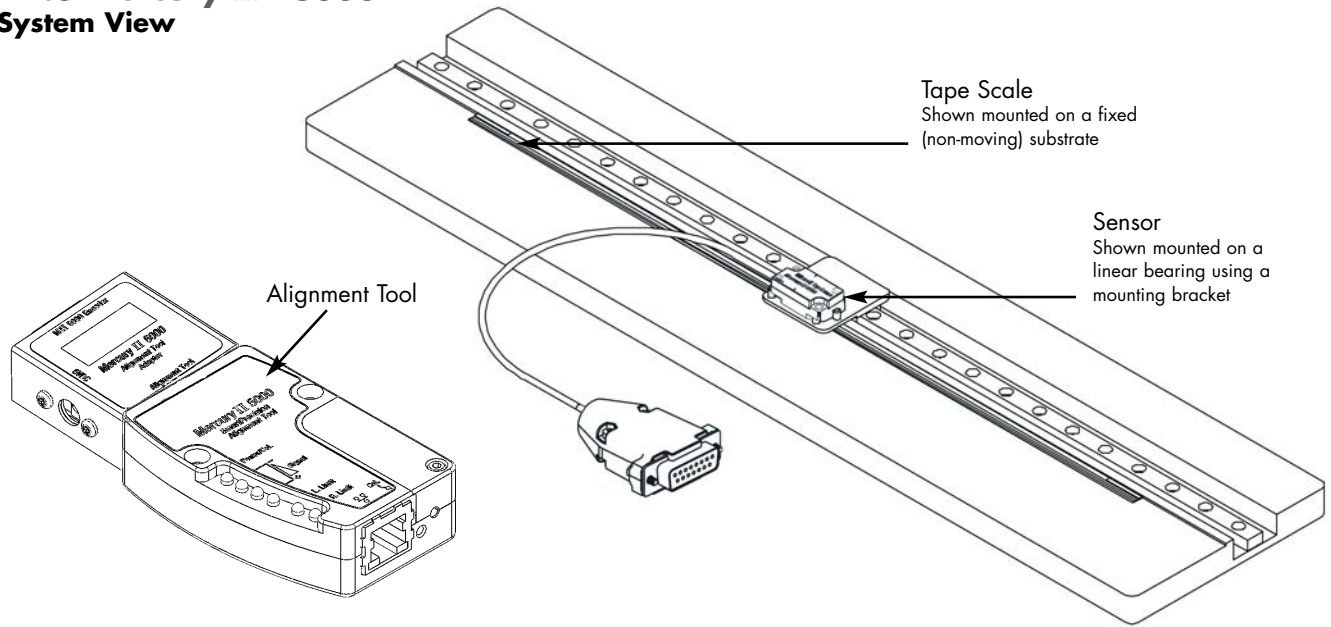

Expanded View

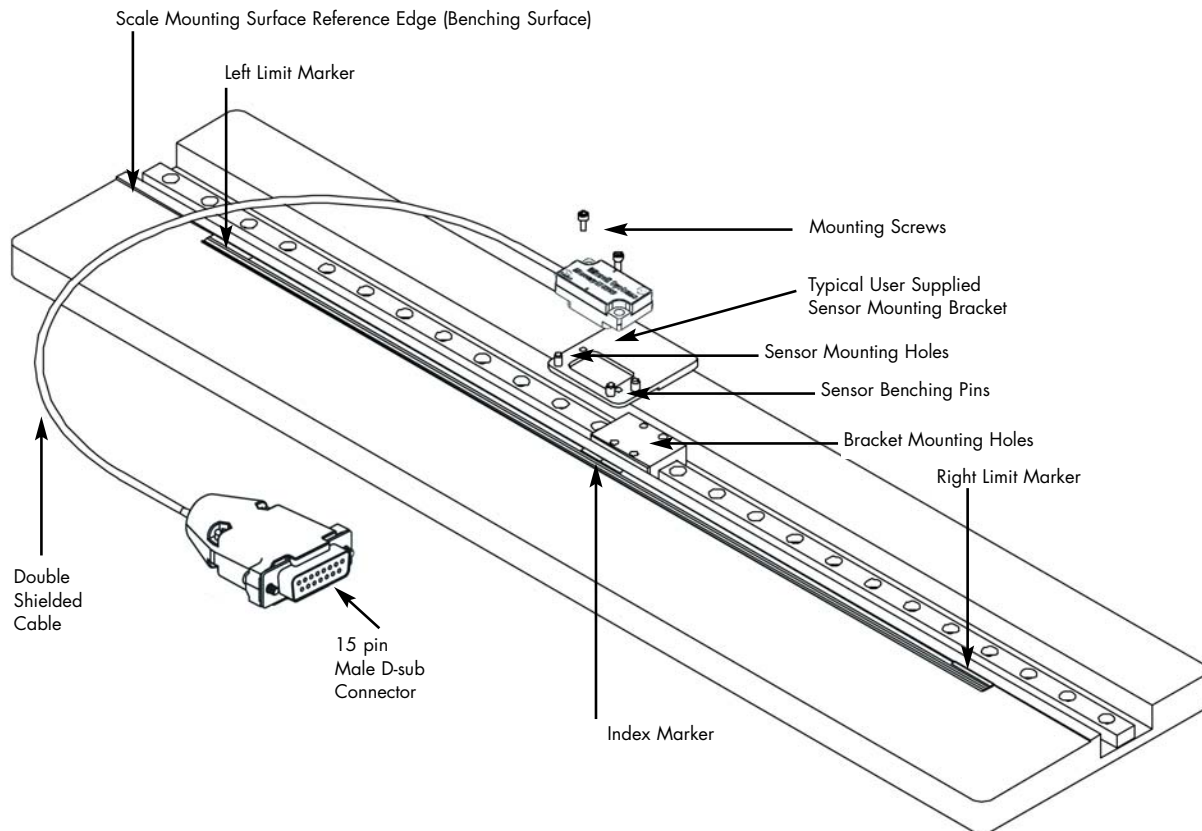

System Overview

PurePrecision™ Tape Scale

A2.1

Items Required for Mercury II™ Encoder Installation Using Tape Scale

In addition to the items in the System Views, you will need the following items available:

- Index and Limit Marker sheet
- Hex Wrench for Sensor Mounting Screws
- Shears
- Tape Applicator Tool
(not required for some installations)
- Finger Cots or talc-free gloves
- Acetone or isopropyl alcohol
- Lint-free cotton cloths or wipes
- Two-part epoxy (Tra-Con Tra-Bond 2116)
- Stick and disposable surface for stirring epoxy
- Stick and disposable surface for stirring epoxy

System Overview

Encoder with Linear Glass Scale

A2.2

Items Required for Mercury II™ Encoder Installation Using Glass Scales

In addition to the items in the System Views, you will need the following items available:

- Index and Limit Marker sheet
- Hex Wrench for Sensor Mounting Screws
- Finger Cots or talc-free gloves
- Acetone or isopropyl alcohol
- Lint-free cotton cloths or wipes
- Two-part epoxy (Tra-Con Tra-Bond 2116)
- Stick and disposable surface for stirring epoxy
- Silicone adhesive

Sensor Head Installation

B1.0 Verify Sensor Mounting Surface Height

Verify that the vertical distance between the reference surface of the sensor and the top of the scale is as follows:

Tape scale after blue protective film is removed:
3.09 mm +/-0.13

Linear or rotary glass scales: 2.93 mm +/-0.13

Check the height at a location on the scale where there are no index or limit markers.

B1.1

Install the sensor on the mounting surface referencing the appropriate datum surface as shown on the Interface Drawing. Use two M-2 screws to loosely affix the sensor.

Benching pins may be used to locate the sensor if the system's mechanical tolerances are adequate. Refer to the Interface Drawing for recommended locations and heights of pins.

Mercury II Sensor Alignment Tolerances	
Axis	Alignment Tolerance
X	Direction of Motion
Y	± 0.20mm
Z	± 0.15mm
θ_X	± 1.0°
θ_Y	± 1.0°
θ_Z	± 2.0°

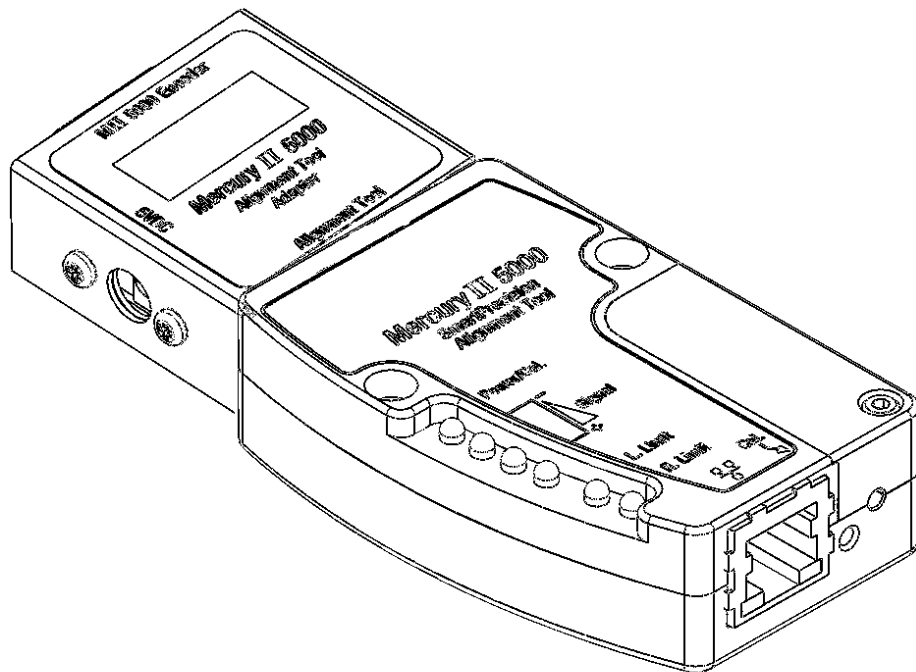

Sensor Head Alignment -

Mercury II™ 6000 Models

B2.0

SmartPrecision Alignment Tool

Installing the MII6000 requires sensor alignment and setup using the MII5000 SmartPrecision Alignment Tool.

The Alignment Tool can perform sensor alignment, calibration and setup by two methods -

A) "Pushbutton:" using the Calibration ("Cal.") button and the LED indicators on the Alignment Tool

OR

B) "Software:" Using the SmartPrecision II Software - see B2.4.



Access to Cal. button

Sensor Head Alignment -

Mercury II™ 6000 Models

B2.1

MII6000 Pushbutton Setup - Sensor Alignment

Make sure that the 5VDC power input is disconnected. Connect the MII6000 encoder to the SmartPrecision Alignment Tool. Insert the 5VDC power connector and apply power.

B2.1.1 To enter Alignment Mode, push and release the Cal. button quickly (within a second). The limit LED's will begin to blink slowly.

B2.1.2 Align the sensor by slowly sliding the sensor on its mounting surface in the Y or θ_z directions until the green Signal Strength LED is illuminated. Tighten the sensor mounting screws (0.37Nm [3.3 inch-lbs.] maximum torque).

B2.1.3 Move the sensor over the index mark and confirm that the green Signal Strength LED blinks. (If the green Signal Strength LED does not blink when the sensor passes over the index, loosen the mounting screws and repeat the alignment procedure.)

B2.1.4 Move the sensor over the entire length of the scale. If the green signal strength LED remains illuminated over the entire length of travel (the yellow and red LED's do not illuminate), proceed to the next step. Otherwise, clean the scale and try again. If cleaning the scale is not successful, loosen the sensor mounting screws and repeat the alignment procedure.

B2.1.5 Push and release the Cal. button quickly to exit Alignment Mode. The limit LED's will stop blinking.

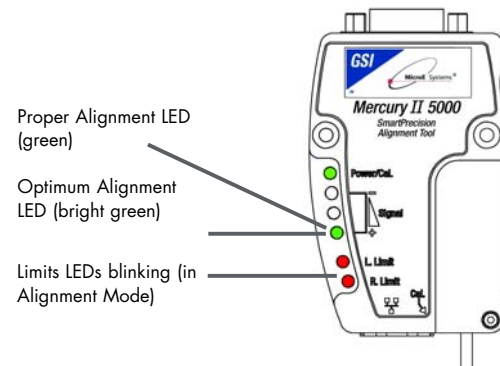
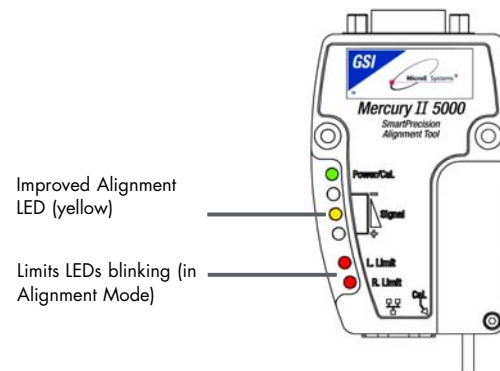
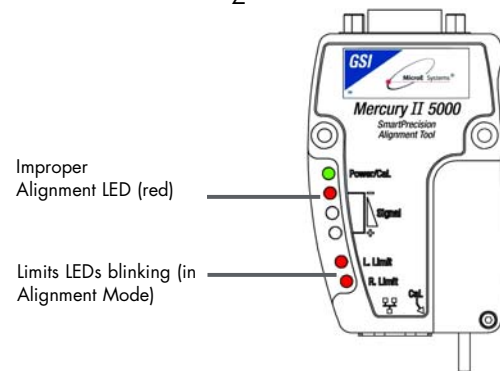
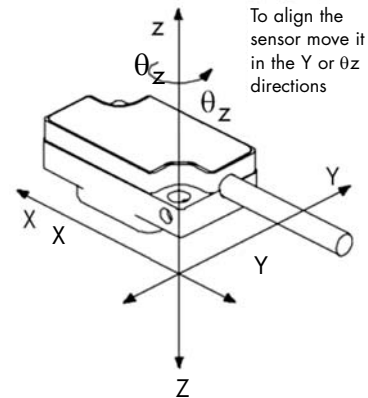

Setup and Calibration -

Mercury II™ 6000 Models – Pushbutton Setup

B2.2

MII6000 Pushbutton Setup - Setup / Calibration - Linear Scales, or Rotary Scales Used in Applications <360°

Setup / calibration must be performed whenever the sensor is moved or the scale is replaced.

Note: all procedures below must be performed at $\leq 1\text{m/s}$ relative motion between the sensor and the scale.

- B2.2.1 To start calibration, push and hold the Cal. button for about two seconds – until the Power/Cal. LED starts blinking slowly.
- B2.2.2 Move the sensor 50mm to perform Gain / Offset / Phase calibration. Move the sensor back and forth if your scale has <50mm of measuring length. After calibration both limit LED's come on steady.
- B2.2.3 Move the sensor to an area of the scale away from the index and limit markers. Push the Cal. button once quickly. The Power/Cal. LED will start blinking quickly.
- B2.2.4 Move the sensor over the index up to 20 passes (one pass is a cycle back and forth). The Left Limit LED will start blinking quickly. (Note: if the sensor is positioned over the left limit marker, the Left Limit LED will come on steady).
- B2.2.5 Move the sensor over the left limit marker

Note:

Calibration of the left and right limits should always be performed while "Limit Polarity" is in the "Limits Normal" mode. This mode is set in the "Calibration and Align" tab of SmartPrecision II Software.

and press the Cal. button once quickly. The Right Limit LED will start blinking. (Note: if the sensor is positioned over the right limit marker, the Right Limit LED will come on steady.)

- B2.2.6 Move the sensor over the right limit marker and press the Cal. button once quickly. All LED's will flash together twice to indicate that setup is completed.
- B2.2.7 The encoder is now ready for connection to the controller for use in servo control.

Note: to skip any portion of this calibration and and move on to the next portion, push and hold the Cal. button for two seconds.

Setup and Calibration -

Mercury II™ 6000 Models – Pushbutton Setup

B2.3

MII6000 Pushbutton Setup - Setup / Calibration - Rotary Scales Used in Applications >360° Without Limit Markers

Setup / calibration must be performed whenever the sensor is moved or the scale is replaced.

Note: all procedures below must be performed at $\leq 1m/s$ relative motion between the sensor and the scale.

- B2.3.1 To start calibration, push and hold the Cal. button for about 10 seconds – until the three signal LED's blink twice to indicate that rotary calibration has been activated.
- B2.3.2 Move the sensor 50mm to perform Gain / Offset / Phase calibration. After calibration both limit LED's come on steady. Move the sensor back and forth if your scale has a circumference of <50mm.
- B2.3.3 Move the sensor to an area of the scale away from the index marker. Push the Cal. button once quickly. The Power/Cal. LED will start blinking quickly.
- B2.3.4 Move the sensor over the index up to 20 passes (one pass is a cycle back and forth). The Power/Cal. LED and both limits LED's will start to blink in sets of three.
- B2.3.5 Move the sensor away from the index and press the Cal. button once quickly. The Power/Cal. LED and both limit LED's will start to blink in sets of two.
- B2.3.6 Move the sensor over the index once. The LED's will change to Power/Cal. LED and both limit LED's blinking just once.
- B2.3.7 Make a full revolution of the rotary scale in order to go over the index again in the same direction. The two passes over the index must be at least 1000 20 μ m fringes apart (equivalent of 20mm linear travel), if they are not the Alignment Tool will wait for another pass that is 1000 fringes from the first.
- B2.3.8 The encoder is now ready for connection to the controller for use in servo control.

Note: to skip any portion of this calibration and and move on to the next portion, push and hold the Cal. button for two seconds.

Sensor Head Alignment -

Mercury II™ 6000 Models – Setup using Software

B2.4.1

Connect the Alignment Tool and Encoder

Verify that the Alignment Tool Adapter / SmartPrecision II Alignment Tool is not powered. Connect the MII 6000 encoder and Ethernet cable as shown below. Power up the Alignment Tool Adapter / SmartPrecision II Alignment Tool by plugging in the power supply. The green LED labeled "On" will light when the Alignment Tool is powered.

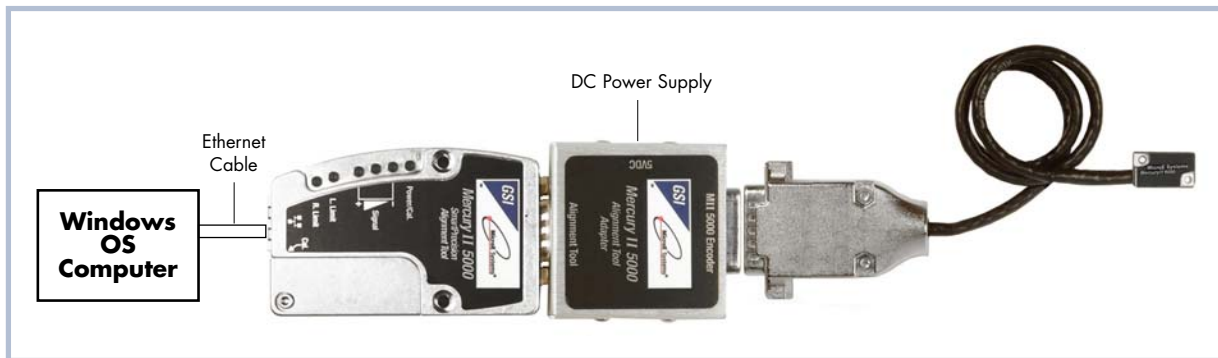

B2.4.2

Find the Encoder Using FindMII.exe

Once the encoder is connected to the computer using an Ethernet cable, run the program FindMII.exe, version 1.2.2.1 or higher, available by downloading from www.microesys.com/m2/software.html. This program locates the encoder and allows you to use the SmartPrecision II Software embedded in it. Once located, the FindMII program will list all the encoders connected to the network.

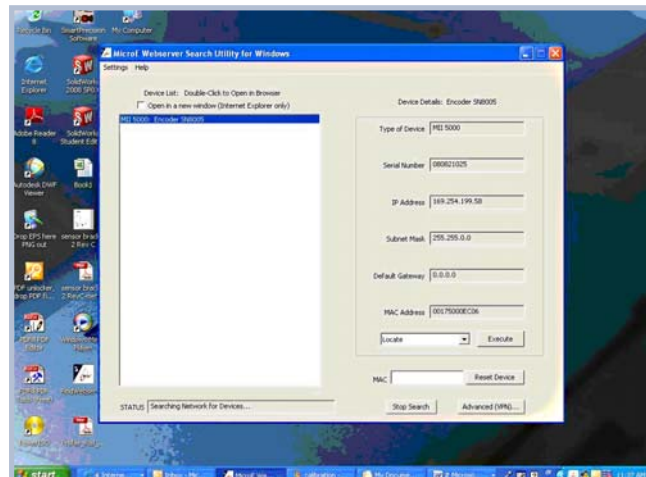

Double-click the name of the encoder to open the SmartPrecision II Software.

Sensor Head Alignment and Calibration

Mercury II™ 6000 Models – Setup using Software

B2.4.3

Calibrating the Encoder

Once the SmartPrecision II Software is open, the encoder can be aligned and calibrated using the Calibrate and Align tab. Click on the Calibrate and Align tab and perform sensor alignment using the Align Mode “Turn On” and “Turn Off” buttons. Turn on Align Mode, adjust the sensor until the maximum signal strength is achieved, tighten the sensor mounting screws, check for index indication (using the status display at the top right of the screen), and turn off Align Mode.

Next, perform setup by checking the Calibrate GOP, Calibrate Index, Set Left Limit, and Set Right Limit boxes, as shown.

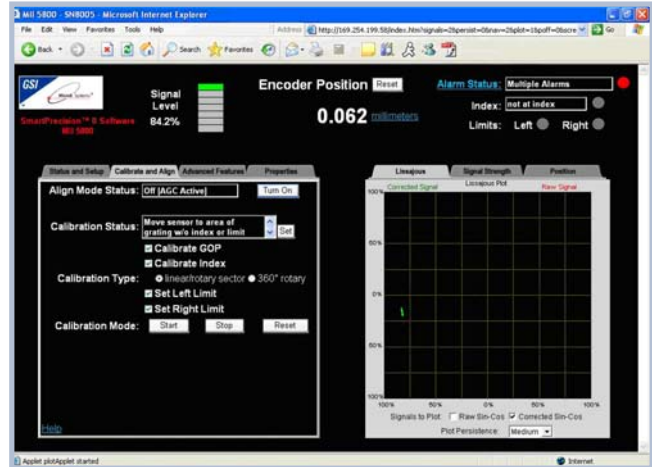

Ensure that the calibration type is correctly selected for your encoder and press Start. Follow the steps in the Calibration Status Box to complete setup of the MII 6000 encoder.

Sensor Head Alignment -

Mercury II™ 6000 Models – Alignment Verification with Connector LEDs

B3.0

Connector LED Indicators

Once the encoder is aligned and calibrated using the alignment tool, alignment can be visually verified using the LED indicators on the MII6000 sensor's connector. The left hand indicator reports signal strength of the main track. The right hand indicator reports the presence of the left limit, right limit, and index marks.

Normal Operation



Grounding Instructions -

Mercury II™ 6000

C1.0 Grounding Instructions

For Mercury II 6000 encoder systems to operate reliably, it is essential that the sensor and cable shield are grounded properly according to the following instructions. The diagrams below show how to make the connections when the encoder's connector is plugged into the customer's controller chassis. If a customer-supplied extension cable is used, it should be a double shielded cable with conductive connector shells and must provide complete shielding over the conductors contained within it over its entire length. Furthermore, the shields should be grounded at the connection to the controller chassis the same way as the encoder connectors in the diagrams below.

NOTE:

For best performance, isolate the encoder outer shield from motor cable shields and separate the encoder cable as far as possible from motor cables.

Sensor mounted with good electrical contact to a well-grounded surface (preferred)

C1.1.1 15-pin D-sub connector grounding:
The encoder's connector shell must be in intimate, electrically conductive contact with the customer-supplied mating connector, which must be isolated from the controller's ground. If a customer-supplied shielded cable connects the encoder to the controller, then the outer shield on the customer-supplied cable must be isolated from the controller's ground.

C1.1.2 The sensor mounting surface must have a low impedance (DC/AC) connection to ground. The encoder sensor mounting surface may have to be masked during painting or anodizing to insure good electrical contact with the sensor.

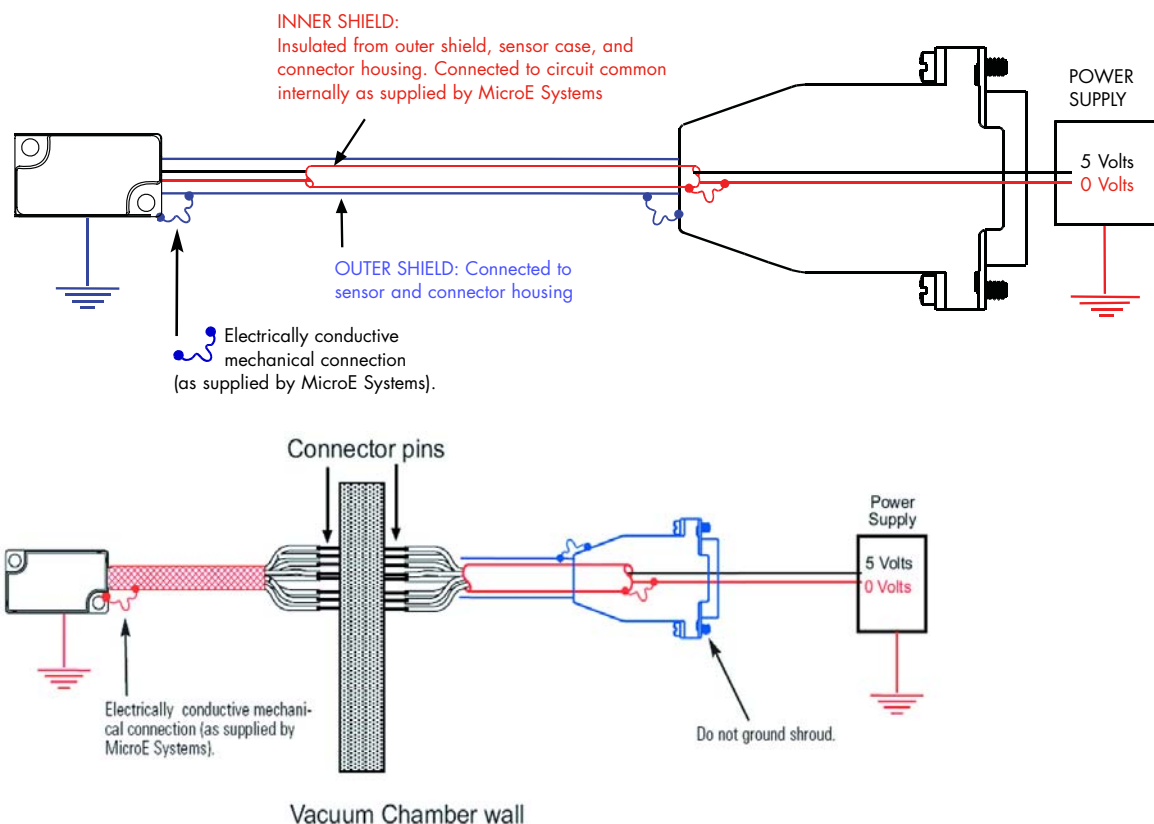

Grounding Instructions -

Mercury II™ 6000

Sensor mounted to a surface that is grounded through bearings or a poorly-grounded surface, or mounted to a non-conducting surface

- C1.2.1 15-pin D-sub connector grounding: The encoder's connector shell must be in intimate, electrically conductive contact with the customer-supplied mating connector, which must be connected to the controller's ground. If a customer-supplied shielded cable connects the encoder to the controller, then the outer shield on the customer-supplied cable must be connected to the controller's ground. The controller must be grounded to earth at the point of installation.
- C1.2.2 The encoder sensor must be mounted so that it is electrically isolated from ground.

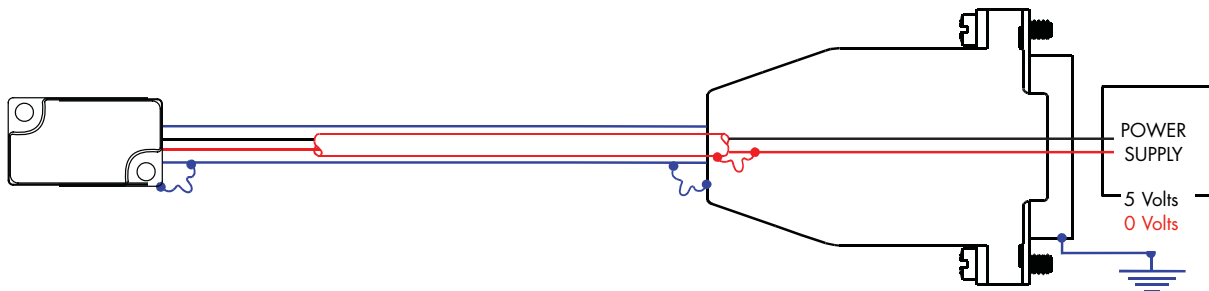

Recommendations for Power; Installation Considerations

C2.0

Recommendations for Power

Mercury II™ encoders require a minimum of 4.75V DC continuously. When designing circuits and extension cables to use Mercury II encoders, be sure to account for voltage loss over distance and tolerances from the nominal supply voltage so that at least 4.75V DC is available to the Mercury II encoder under all operating conditions. The input voltage should not exceed 5.25V DC.

C2.1

Installation Considerations

The Mercury II encoder is a precision electronic instrument. It has been designed to function in a wide range of applications and environments. To take full advantage of the Mercury II modular system design, considerations should be made to allow easy access to the sensor (and interpolator modules where applicable) for service and/or replacement.

For optimal performance and reliability:

DO follow standard ESD precautions while handling the sensor and interpolator.

DO allow proper clearance for sensor head alignment.

DO follow setup and calibration instructions for the encoder system.

DO, where possible, install the scales in an inverted or vertical position to minimize accumulation of dust.

DO NOT store sensors in an uncontrolled environment.

DO NOT electrically overstress the sensor (Power supply ripple/noise).

DO NOT intentionally “hot swap” the sensor if the device is energized.

DO NOT use in high contamination applications (dust, oil, excessive humidity, or other airborne contaminants.).

Recommended Interface Termination

C3.0

Customer Differential Line Receiver:

For Mercury II™ 6000

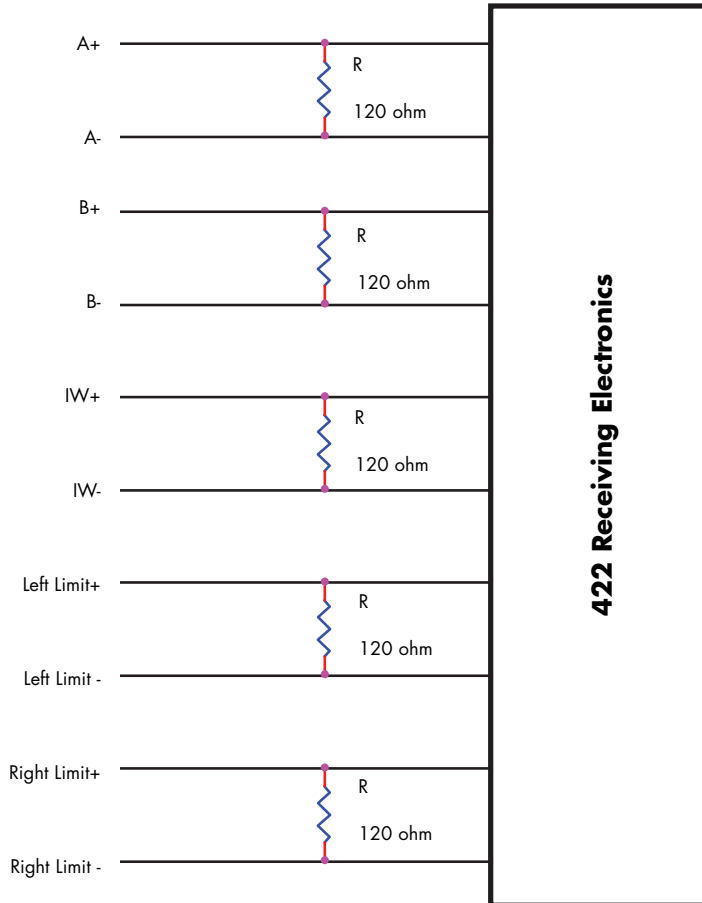

Customer Interface Cable Requirements

C4.0

Customer cables that interface to Mercury II™ series encoders must have the following characteristics:

- Twisted pair signal wiring.
- Characteristic impedance of 100-120 ohms.
- Sufficient wire gauge to meet the minimum voltage requirement at the encoder, for example 24AWG gauge wire for a 2m length cable. Examples of acceptable cables with 24AWG gauge wire and 4 twisted pairs are Belden 9831, 8104, and 9844 or other manufacturer's equivalents.
- Single shield cable with a minimum of 90% coverage. Note that a double shielded cable may be required in high-noise applications.

C4.1

Signal Wiring

Each differential signal should be connected to a corresponding twisted pair as follows:

Mercury II™ 6000	
Signal	Twisted Pair
A+	Pair 1
A-	
B+	Pair 2
B-	
Index+	Pair 3
Index-	
Left Limit +	Pair 4
Left Limit -	
Right Limit +	Pair 5
Right Limit -	
+5V	Pair 6
GND	

Customer Interface Cable Requirements

C4.2

Shield Termination:

The customer's cable shield should be in 360° contact with the connector shroud and the connector shell to provide complete shielding. The connector shell should be metal with conductive surfaces. Suggested metal connector shells for use with Mercury II™ encoders: AMP 748676-1 or equivalent; where the dash number is dependent on the customer's outside cable diameter. The shield should be terminated as illustrated in the following diagram.

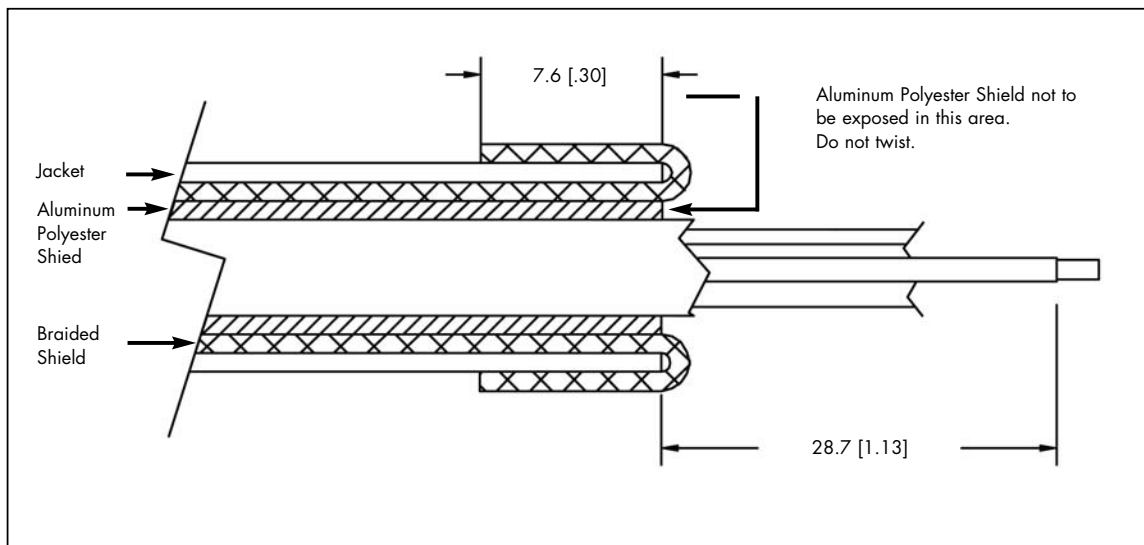

Fold braided shield back over jacket. Example shows double-shielded cable.
Dimensions shown are for illustration only.

Index Speed Considerations

for MII6000

C5.0 Maximum Speed for MII6000 Index after Power-up (MII6800, MII6700 and MII6500 Models)

Each time an MII6800, MII6700 or MII6500 encoder is powered up, the first pass over the index mark must occur at a speed ≤ 1 m/s. Once the index is initially detected, the index will function at all speeds (up to 10m/s) until the next power cycle.

Troubleshooting

D1.0

Problem

The Power/Calibration indicator will not come on.

Solution

- Make sure that the SmartPrecision™ II electronics' 15-pin D-sub connector is fully seated and connected.
- Confirm that +5 Volts DC is being applied to pin 7 and 8 on the SmartPrecision II electronics' 15-pin connector and that pin 2 and 9 is connected to ground.

Problem

Can't get the SmartPrecision II electronics' "Signal" LEDs better than red or yellow; or the green, " Proper Alignment" indicator doesn't stay illuminated over the full length of the scale.

Solution

- Verify that the sensor is mounted in the correct orientation with reference to the scale and scale mounting reference edge. Refer to the Interface Drawing.
- Verify that the sensor has been aligned to the scale and that the mounting screws are tight. Check the dimensions for the mechanical mounting holes (and clamps if any) to make sure that the sensor is correctly located over the scale in the Y and Z dimensions. Refer to the Interface Drawing.
- Check that the scale is firmly mounted and can't jiggle or move in any direction other than the axis of motion.
- Make sure that the scale is clean over its entire length or circumference.

Problem

The green Power/Calibration indicator LED or limit LEDs are flashing unexpectedly.

Solution

- Part of the normal setup procedure is to activate the SmartPrecision II Electronics' Calibration/Setup process by pressing the recessed button in the electronics module. The Power/Cal. LED or limit LEDs will begin to flash until the relevant setup process is complete. See the instructions beginning at section B2.2.

Problem

Can't Complete the Calibration/Setup process - the green Power/Calibration indicator doesn't stop flashing.

Solution

- Verify that the sensor is mounted in the correct orientation to the scale for the desired index mark. Refer to the Interface Drawing.
- Refer to section B1.0 to insure proper sensor alignment and index marker operation.

Contacting MicroE



GSI
TM

Precision Technologies

GSI General Scanning Optical Sensors

GSI MicroE Systems®

GSI WESTWIND®

GSI General Scanning Thermal Probes

GSI GSI Lasers®

GSI General Optics®

Semiconductor Systems

GSI WaferRepair™

GSI WaferTrim™

GSI WaferMark®

GSI CircuitTrim™

GSI SVS™

A World of Enabling Technologies

Bringing Your Advanced Manufacturing Applications to Life

To learn more about Mercury™ encoders, or other MicroE Systems products, visit: www.microesys.com.

To learn more about GSI Group, visit our corporate web site: www.gsig.com.

MicroE Systems is a world leader in optical encoder technology with offices in major industrial centers around the globe. As one of fourteen product brands that comprise GSI Group, we deliver enabling technology that brings advanced applications to life in the motion control, medical, semiconductor, electronics and industrial markets.

Headquarters

MicroE Systems
125 Middlesex Turnpike.
Bedford, MA 01730 USA
Tel : 781-266-5700
Fax: 781-266-5112

www.microesys.com

Email: info@microesys.com

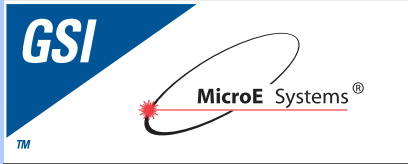

Mercury II™ Pure Precision™ Tape Scale

Installation Manual and Reference Guide



MicroE Systems - World Headquarters: 125 Middlesex Turnpike, Bedford, MA USA 01730-1409

IM-Mercury_II_Tape_Scale_Rev.C

www.microesys.com

info@microesys.com

T. 781-266-5700

F. 781-266-5112

©2010 MicroE Systems

Introduction

MicroE Systems was founded to advance encoder technology to a level never before achieved. Our objective was to design encoder systems that would be small enough to fit into densely packed OEM equipment designs, affordable enough for cost-sensitive applications and easy enough to enable installation, setup and alignment by assemblers with little training. We are pleased to say that all of these goals have been realized with the introduction of the original Mercury™ family of encoder systems. Now, the Mercury II series offers all of that plus improved performance, ease of use and versatility.

Precautions



- 1 Follow standard ESD precautions. Turn power off before connecting the sensor. Do not touch the electrical pins without static protection such as a grounded wrist strap.
- 2 Do not touch the glass scale unless you are wearing talc-free gloves or finger cots. Please read this installation manual for full instructions.

LASER SAFETY INFORMATION: Mercury & ChipEncoder

This product is sold solely for use as a component (or replacement) in an electronic product; therefore it is not required to, and does not comply with, 21 CFR 1040.10 and 1040.11 which pertain to complete laser products. The manufacturer of the complete system-level electronic product is responsible for complying with 21 CFR 1040.10 and 1040.11 and for providing the user with all necessary safety warnings and information.

MicroE encoders contain an infrared laser diode or diodes. Emitted invisible laser radiation levels have been measured to be within the CDRH Class 1 range, which is not considered hazardous; however, to minimize exposure to the diverging beam, the encoder sensor should be installed in its operational configuration in close proximity to the encoder scale before power is applied.



- Invisible laser radiation; wavelength: 850 nm
- Max power 2.4 mW CW (4.8 mW CW for Mercury II™)
- CAUTION – The use of optical instruments with this product will increase eye hazard. DO NOT VIEW DIRECTLY WITH OPTICAL INSTRUMENTS (MICROSCOPES, EYE LOUPES OR MAGNIFIERS).
- All maintenance procedures such as cleaning must be performed with the MicroE encoder turned off.
- Do not insert any reflective surface into the beam path when the encoder is powered.
- Do not attempt to service the MicroE encoder.

Patents

Covered by the following patents: US 5,991,249; EP 895,239; JP 3,025,237; US 6,897,435; and EP 1,451,933. Additional patents and patents pending may apply.

 Mercury II models are CE and RoHS compliant.

System Overview

PurePrecision™ Tape Scale

A1.0

Items Required for Mercury II™ Encoder Installation Using Tape Scale

In addition to the items in the System Views, you will need the following items available:

- Index and Limit Marker sheet
- Hex Wrench for Sensor Mounting Screws
- Shears
- Tape Applicator Tool
(not required for some installations)
- Finger Cots or talc-free gloves
- Acetone or isopropyl alcohol
- Lint-free cotton cloths or wipes
- Two-part epoxy (Tra-Con Tra-Bond 2116)
- Stick and disposable surface for stirring epoxy

Pre-Installation Information and Precautions

B1.0

Read all instructions completely before beginning the installation process.

Make sure to follow the instruction sequence throughout the installation process.

The PurePrecision™ Tape Scale is a precision metrological device. Handle it with the utmost care at all times.



Avoid bending the tape scale to a radius less than 90mm (3.5 inches)

Avoid twisting the PurePrecision Tape Scale.

Do not let any sharp object touch the tape scale after the blue protective film is removed.

The PurePrecision Tape Scale is protected by a blue film on the top that prevents contamination and damage to the grating pattern during installation.

Once the adhesive on the tape scale is exposed (by removing the adhesive liner), do not touch the adhesive or allow any contamination to come into contact with it.

PurePrecision Tape Scale, Index and Limit Markers are designed for one time installation only.

If removed from the mounting surface for any reason, they should not be used for any kind of reapplication. This will affect the performance and reliability of the encoder system.

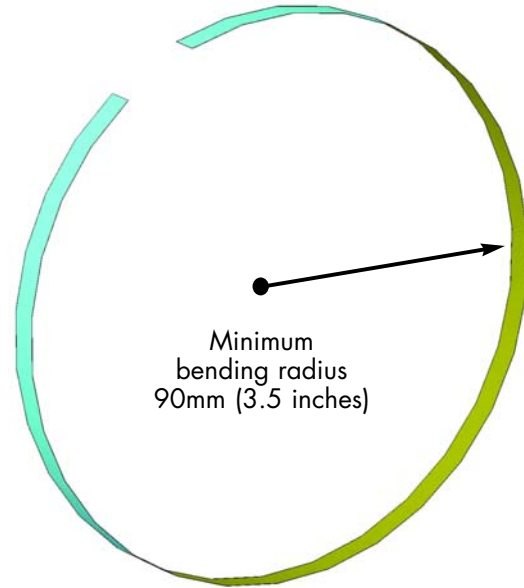

Pre-Installation Information and Precautions

The adhesive on the PurePrecision™ Tape Scale is permanent.



Do not touch the adhesive once the adhesive liner is removed.

Do not remove the tape scale from the mounting surface once it has been installed.

Do not reinstall the tape scale if it has already been installed once. If the tape scale is removed and reinstalled again, the encoder performance will be degraded.

Avoid any contamination to the adhesive. Any particulate matter or other contamination that is trapped between the scale and the mounting surface will affect encoder performance.

Flowchart for PurePrecision™ Tape Scale Installation

B2.0

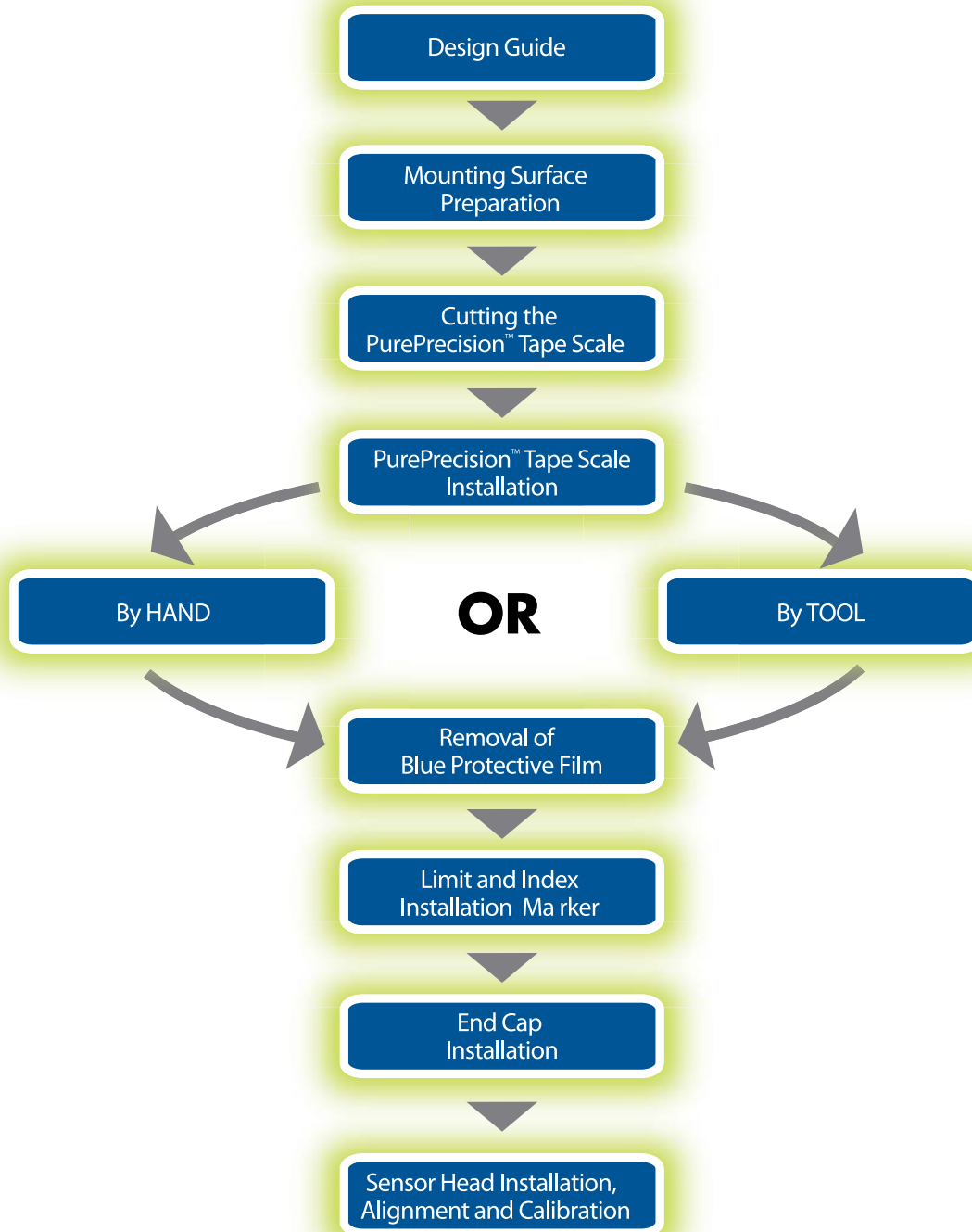

Design Guide

B3.0

Verify the tolerances of the scale's mounting surface given in the Interface Drawing.

B3.1

Verify the dimensions of the scale benching edge (groove or straight edge) given in the Interface Drawing.

B3.2

Calculate the length of PurePrecision™ Tape Scale required for your application using the formula $ML + 40$ mm (ML - Measuring Length). Refer to the Interface Drawing.

B3.3

In order to install the tape scale against a straight edge, either the Applicator Tool or hands can be used.

It is recommended to use the Applicator Tool for all installations against a straight edge and highly recommended for lengths greater than 250mm (10 inches).

B3.4

In the case where the tape scale is to be installed in a 6mm-wide groove, it has to be done by hand only. The Applicator Tool is not compatible with a 6mm groove. Refer to the Interface Drawing.

B3.5

If machining the mounting surface is undesirable, or not possible, a temporary straight edge can be used that meets the dimensions and tolerances specified in the Interface Drawing.

Two kinds of temporary straight edge can be used -

- **Type I -**

Temporary Straight Edge of thickness 0.76 ± 0.05 mm (0.030 ± 0.002 inches). Refer to the Interface Drawing for additional dimensional requirements. A steel rule may be one of the options for this type of temporary straight edge.

NOTE:

The guide edge of the applicator tool (the edge that comes in contact with the mounting surface reference edge during installation of tape scale) for this application is located on its bottom surface. See Section B6.2 for further information.

- **Type II -**

Temporary straight edge with minimum thickness 9.53mm (0.375 inches). Refer to the Interface Drawing for additional dimensional requirements.

NOTE:

The guide edge of the Applicator Tool for this application is located on the outside surface. See Section B6.2 for further information.

The tape scale will be offset from the temporary straight edge for this application.

When using Type II temporary straight edge, another temporary benching surface may be required to install the index and limit markers due to the offset.

Mounting Surface Preparation

B4.0

Inspect the mounting surface for any machining irregularities. MicroE Systems recommends a surface finish of better than 3.2 micrometers Ra.

B4.1

The straight edge (either permanent or temporary) must be sharp on the benching side in order for the Applicator Tool to use it as a guide. In order for the tape scale to be mounted close to the straight edge, the maximum radius of 0.127 mm (0.005 inches) should be used where the edge meets the bottom of the mounting surface.

B4.2

Thoroughly clean the scale mounting surface and reference edge using a cotton swab or lint-free cloth dampened with isopropyl alcohol or acetone.

Remove all dust and particles.

B4.3

Mark the starting location on the mounting surface where the tape scale will be applied (the left edge of where the scale will be applied when the scale reference edge is away from you). Also mark the locations where the index and limit markers will be applied. Refer to the Interface Drawing to identify the reference points of the markers.

Cutting the PurePrecision™ Tape Scale

B5.0

Uncoil the tape scale and cut it to the required length using the shears provided in the installation kit.



Securely hold the tape scale close to the shear (at an approximate distance of 40mm [1 ½ inches]) near the point of cutting.

Orient the tape scale perpendicular to the shear.

Cut the tape scale in a smooth, continuous motion.

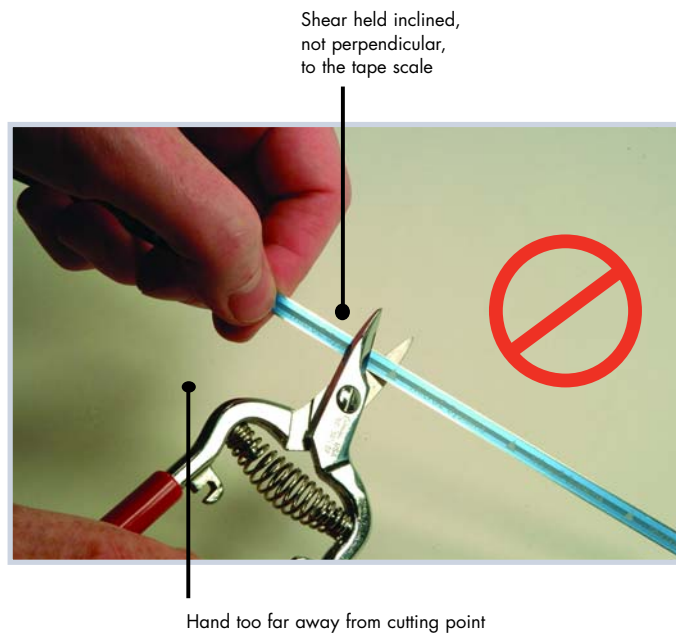
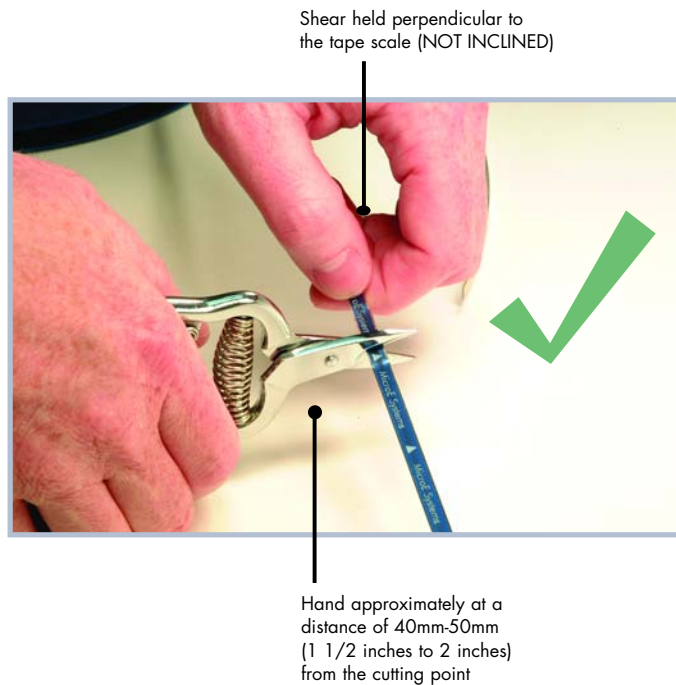

PurePrecision™ Tape Scale Installation

By Hand or Applicator Tool

B6.0 Tape Scale Installation

The tape scale can be installed by two methods -

- i. By HAND, Sec 6.1
- ii. By APPLICATOR TOOL, Sec 6.2

To determine the method of installation, refer to Design Guide, Section B3

B6.1 PurePrecision™ Tape Scale Installation By HAND

B6.1.1
Orient the scale such that the "arrowheads" on the blue protective film are pointing towards the mounting surface reference edge. See figure.

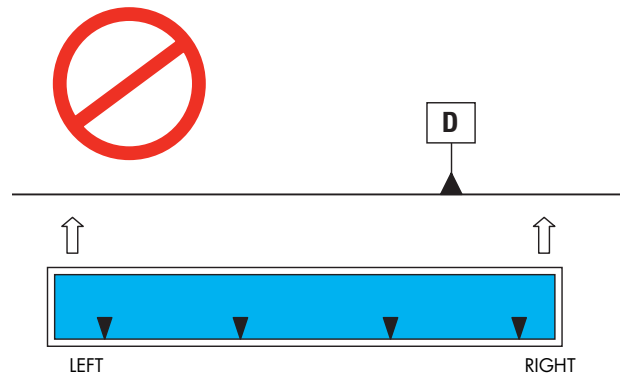
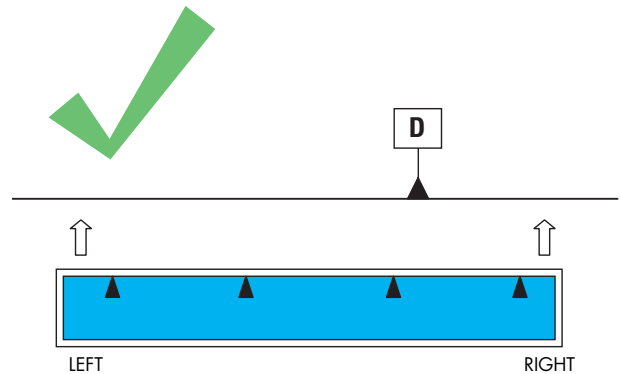

D = Mounting Surface Reference Edge

PurePrecision™ Tape Scale Installation

By Hand

B6.1.2

Removing/peeling the adhesive liner.

Using a sharp tool or fingernails initiate the peeling of the adhesive liner from designated "LEFT END" of the tape scale.

Remove/peel back a short length of about 25mm (1 inch) taking care not to touch the adhesive or allow any particulate contamination.

NOTE:

Be careful not to expose the adhesive liner more than 50mm (2 inches).

Do not peel the blue protective film off at this time.



Adhesive liner peeled off about 25mm (1 inch) from the designated "LEFT END"

B6.1.3

Flip the tape over such that exposed adhesive surface of the tape scale (surface from which the adhesive liner was removed) faces the desired location where the tape needs to be attached.

PurePrecision™ Tape Scale Installation

By Hand

B6.1.4

Placing the PurePrecision™ Tape Scale on the mounting surface reference edge.

Place the edge of the designated "LEFT END" of the tape scale against the mounting surface reference edge as shown and press firmly on the end. Be careful to place the end of the scale correctly at the desired location.

NOTE:

Adhesive exposed by removing the adhesive liner can touch the mounting surface only once.

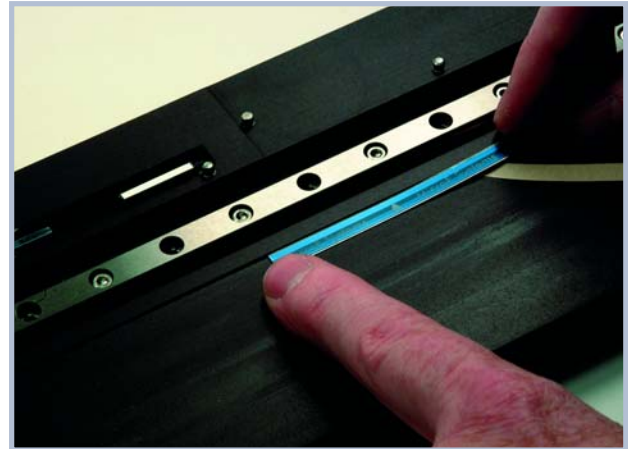

PurePrecision™ Tape Scale Installation

By Hand

B6.1.5

Installing the PurePrecision Tape Scale along the length of the mounting surface.

With one hand remove the adhesive liner progressively as the other hand slides evenly along the length to press the scale against the reference edge and onto the mounting surface.



TIP

Maintain a gap of approximately 25- 35 mm (1-1 ½ inch) between the two hands as you progress along the length.

NOTE:

Make sure that as the tape is slowly being installed, the tape scale is tight against the reference edge.

Once tape scale has been installed discard the adhesive liner.

Hand behind the tape, no obstruction between tape and mounting surface

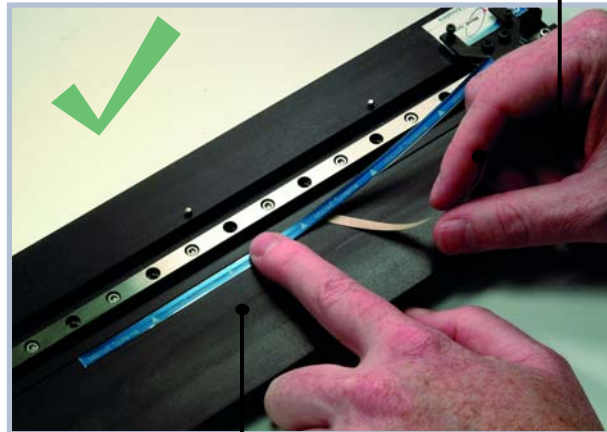

Finger moving progressively along the length of the tape

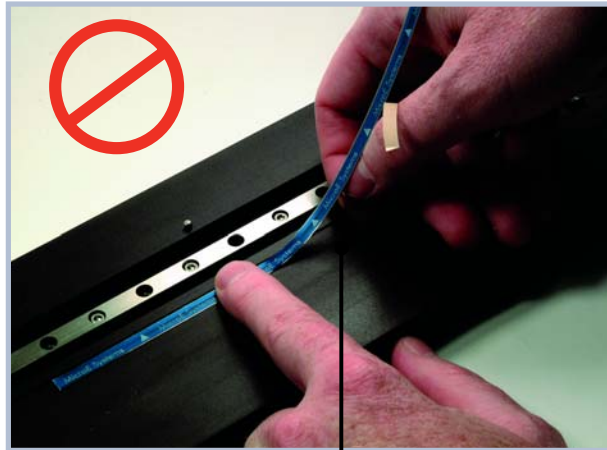

The tape scale should not be bent during installation

PurePrecision™ Tape Scale Installation

By Hand

B6.1.6

Slide your fingers along the entire length of the PurePrecision Tape Scale, pressing firmly, to confirm proper adhesion. Performing this operation more than once is not necessary but will not have any adverse effect.

Proceed to Section B7 of this manual for instruction on removing the blue protective film from the tape scale.

PurePrecision™ Tape Scale Installation

By Applicator Tool

B6.2

Main View of Applicator Tool

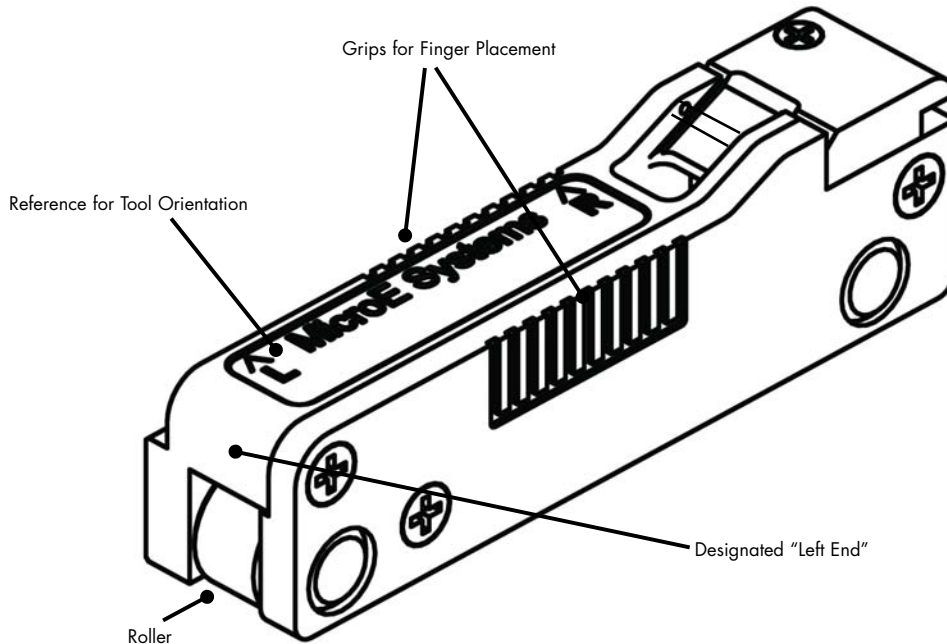

B6.2.1

Make sure that the Applicator Tool is free of any particulate contamination.

B6.2.2

Orienting the Applicator Tool and PurePrecision Tape Scale -

With the mounting surface's reference edge away from you, the tape scale is inserted in the applicator tool such that arrowheads are pointing away from you as shown. The arrowheads on the Applicator Tool should also point away from you.

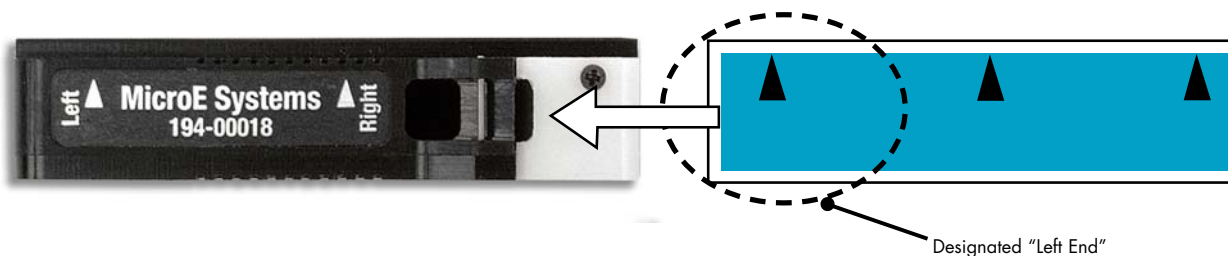

PurePrecision™ Tape Scale Installation

By Applicator Tool

Orienting the Applicator Tool with the mounting surface reference edge.

Once the tape scale has been inserted in the Applicator Tool correctly, the Applicator Tool should be oriented with the mounting surface reference edge (Sec 6.2.8) in such a way that the "MicroE Systems" label is on the left and the white colored end of the tool is on the right.

NOTE:

The following parts of the Applicator Tool interface with the mounting surface reference edge.

- Guide edge at the bottom, when the edge is of thickness 0.030 inch.
- Guide surface when edge is of minimum thickness 0.375 inch.

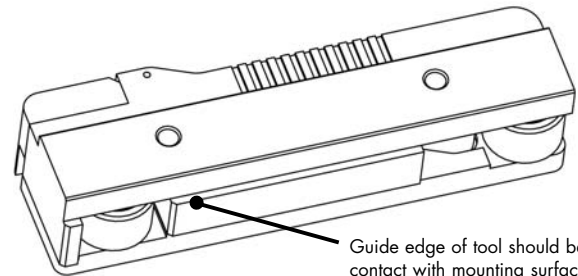

Guide edge of tool should be in contact with mounting surface edge of thickness 0.76mm (0.030 inches)

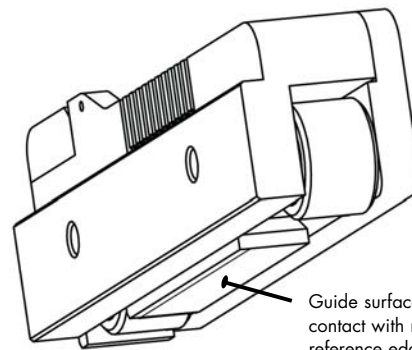
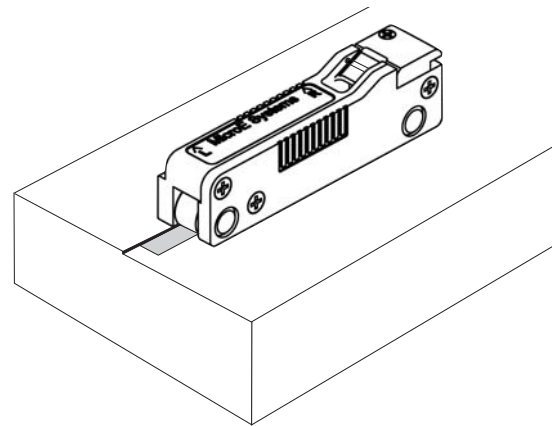

Guide surface of tool should be in contact with mounting surface reference edge is of minimum thickness 0.53mm (0.375 inches)

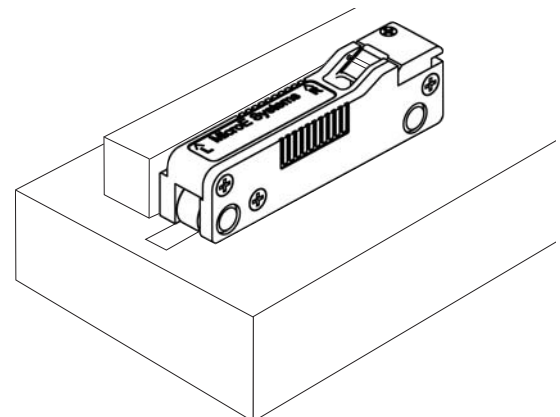

PurePrecision™ Tape Scale Installation

By Applicator Tool

B6.2.3

Peel and curl back a short length - about 30mm (1 inch) - of the adhesive liner from the designated "LEFT END" of the scale as shown. Take care not to touch the adhesive or allow any particle contamination.



Be sure not to crease or fold the adhesive liner. This will hinder the tape scale movement through applicator tool in the next step.

NOTE:

Do not peel off the blue protective film at this time.

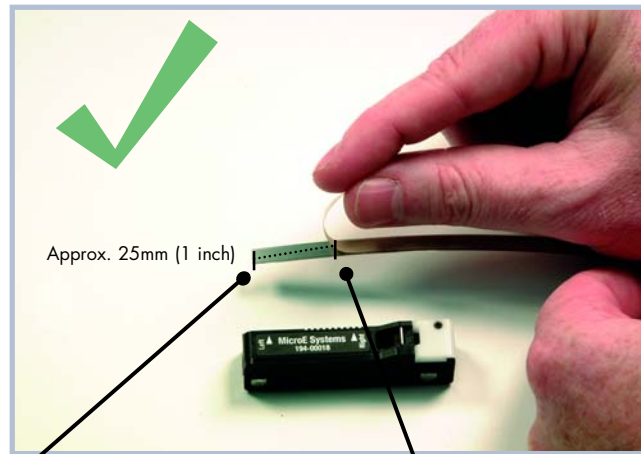

Approx. 25mm (1 inch) of adhesive liner peeled out

Adhesive liner peeled without being creased/folded

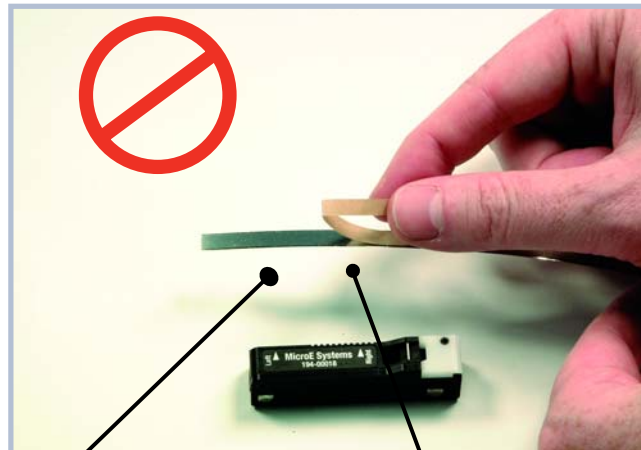

Adhesive liner peeled more than 25mm (1 inch)

Adhesive liner creased/folded while peeling out

PurePrecision™ Tape Scale Installation

By Applicator Tool

B6.2.4

Insert the designated "LEFT END" of the tape scale (arrowhead on blue protective film pointing away) into the Applicator Tool in such a way that the 2 layers of the tape scale go into 2 slots of the Applicator Tool as specified below:

- The tape scale goes underneath the dowel pin as shown and
- The lower adhesive liner enters the slot behind the dowel pin. It is located exactly in between the black colored surface and white color surface as shown.

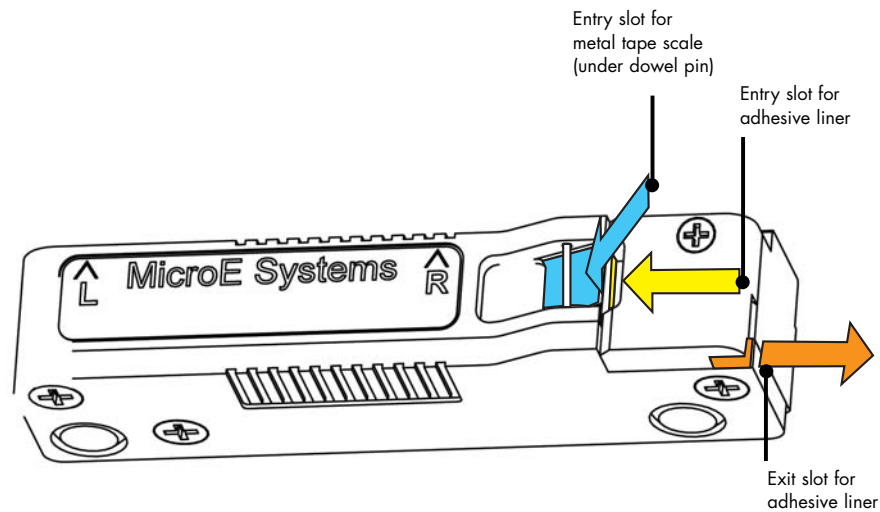
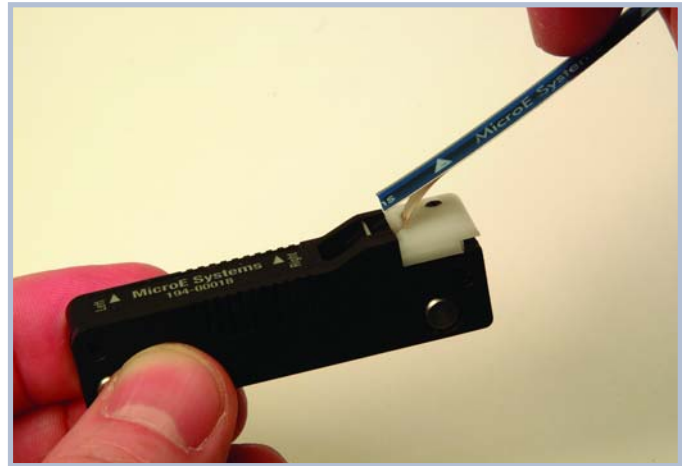

PurePrecision™ Tape Scale Installation

By Applicator Tool

B6.2.5

Once the 2 layers have been inserted into the correct slots, push the tape scale slowly into the Applicator Tool until the adhesive liner emerges from the right side of the Applicator Tool as shown.

NOTE:

Do not pull on the adhesive liner. It will automatically curl out.

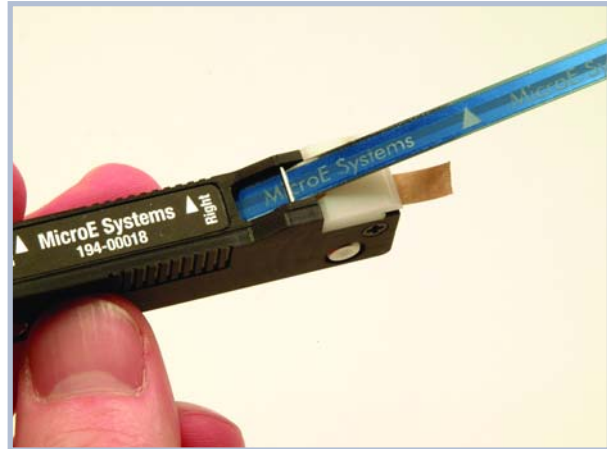

Push the tape scale further into the Applicator Tool until no more than about 25mm (1 inch) of exposed tape scale emerges from the bottom of the tool.

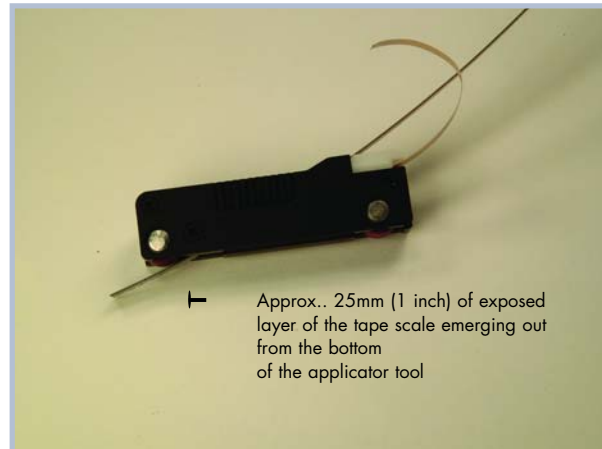

B6.2.6

Before installing the tape scale on your mounting surface, hold the tool as shown. This will ensure that a consistent pressure is applied to the tape scale as it is being applied to the mounting surface.

Place thumb at the center (use the grips provided as reference) on one side.

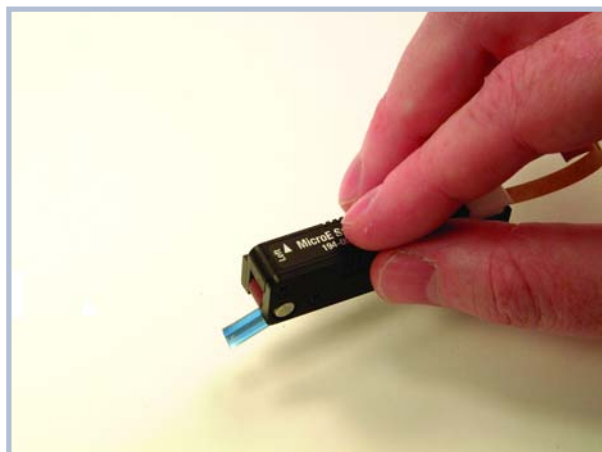

Place index finger at the center on top surface.

Place middle finger at the center (use the grips provided as reference) on the other side.

PurePrecision™ Tape Scale Installation

By Applicator Tool

B6.2.7

At the marked location, place the edge of the tape scale against the mounting surface reference edge and press firmly on the end of the tape scale. Confirm that the following is in contact with the mounting surface reference edge.

- The guide edge on the bottom of the applicator tool when reference edge is 0.76mm (0.030 inch) thick.
- The guide surface (rear side) of the applicator tool when the reference edge is minimum 9.53 mm (0.375 inch) thick.

Make sure that the end of the tape scale does not stick to the mounting surface until it is in position tight against the reference edge.

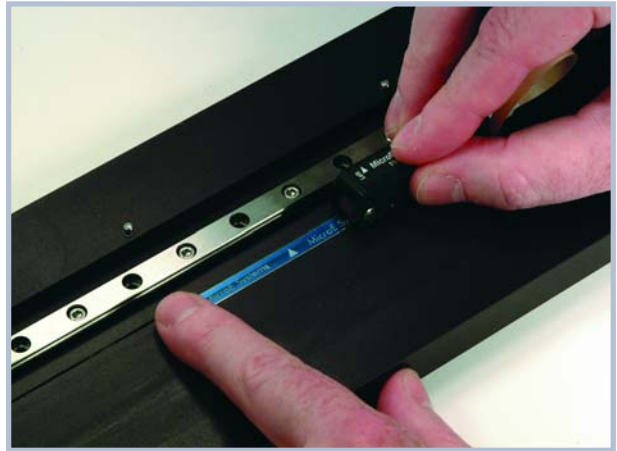

PurePrecision™ Tape Scale Installation

By Applicator Tool

B6.2.8

While pressing down evenly on the tool's rollers and against the mounting surface reference edge, move the tool along the reference edge at a slow and constant speed toward the opposite end of travel. Work from left to right. The adhesive liner is automatically removed while the tape scale is affixed to the mounting surface.

Make sure the pressure on the tool is evenly distributed. Note the finger orientation for holding the applicator tool.

Once the tape scale has been installed, discard the adhesive liner.

Place the Applicator Tool on top of the tape scale and roll it along the length of the scale while pressing down to assure proper adhesion. Performing this function more than once is not necessary but will not have any adverse effect.

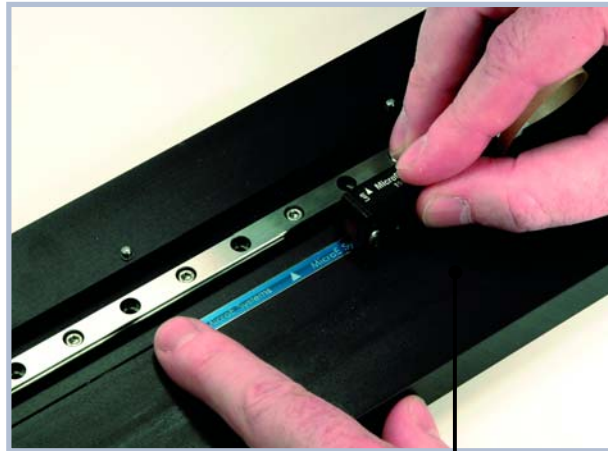

Thumb placed at the center on the side face and other fingers follow along as shown to evenly distribute pressure

NOTE:

Avoid rolling the Applicator Tool on the scale if the blue protective film has been removed.

PurePrecision™ Tape Scale Installation

Removing The Blue Protective Film

B7.0

Put on finger cots or talc-free gloves.

Start the peeling process using fingernails or a sharp tool. Begin from either end of the scale.



Be careful not to damage any area past the first 20mm (0.8 inch) when starting to remove the blue protective film.

If scale damage has occurred beyond first 20mm (0.8 inch), the tape scale may need to be replaced.

The ends of the tape scale will be covered and secured with an end cap.

Clean the tape scale using alcohol or acetone and a lint-free cotton cloth.



Blue protective film being removed

Index and Limit Marker Installation

PurePrecision™ Tape Scale

B8.0

Put on finger cots before starting the index and limit markers installation.

NOTE:

Before installing the Limit and Index Markers, make sure that the blue protective film from the PurePrecision Tape Scale has been removed.

Removing the Index Marker from the Perforated Sheet

NOTE:

Remove the Limit and Index Markers from the perforated sheet slowly to avoid premature detachment of the markers from the handles.

Begin by holding the Limit and Index Marker sheet so that blue protective film is on top (facing you) and the reflective surface is at the bottom.

Starting from the handle, remove the index marker from the perforated sheet by pressing gently from behind with your finger as shown.

It should pull away from the transparent adhesive liner. Holding only the handle, slowly pull the index marker from the perforated sheet.

NOTE:

Be sure to hold the Index and Limit Markers by the handle only. The adhesive on the handle can be touched, however be careful not to touch the adhesive on the areas of the markers that will be applied to the tape scale.

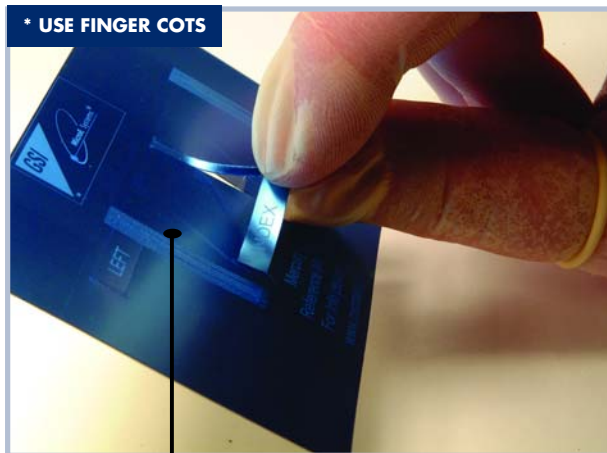
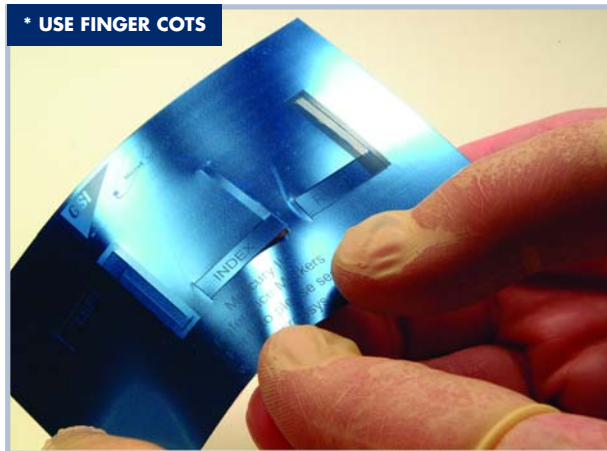
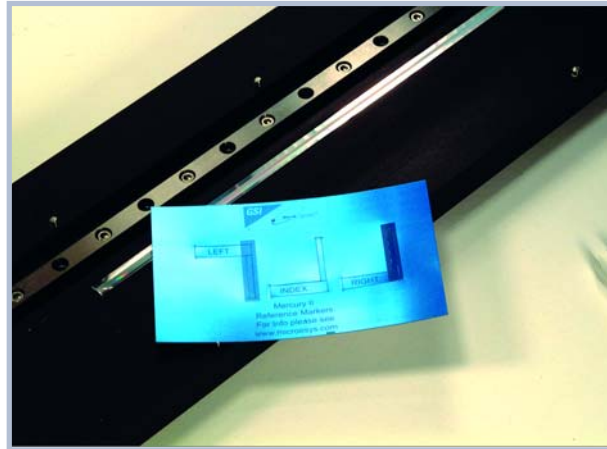

Index being removed from the perforated sheet by holding it by its handle.

Index and Limit Marker Installation

PurePrecision™ Tape Scale

B8.1

Attaching the Index Marker to the Tape Scale

Place the top edge of the marker against the benching edge holding it at a 45° degree angle as shown in the photo.

If the tape scale is installed with an offset from its reference edge, a temporary reference surface such as a small metal block must be used for the index and limit markers.



When the marker is tight against the reference edge (or benching surface), press the marker onto the tape scale with your finger.

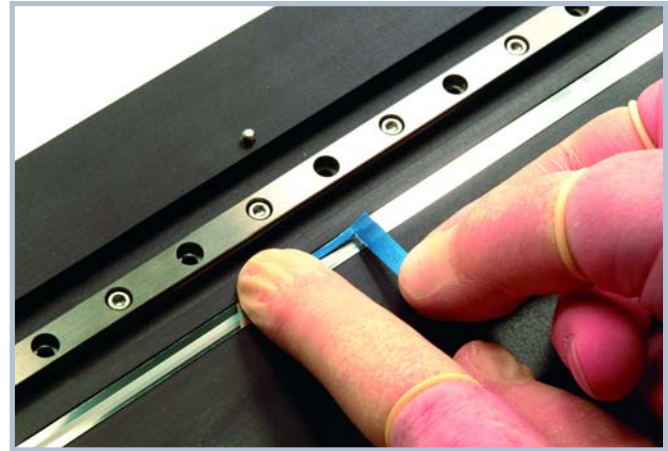

Index and Limit Marker Installation

PurePrecision™ Tape Scale

Press your finger on the marker close to the edge of the handle. Then, with your other hand, pull up on the handle to detach it from the marker. The handle will break away from the marker. Carefully remove the blue protective film from the marker surface.



TIP:

Use fingernails or plastic tweezers to remove the blue protective film, but do not use a hard metal object. Using a hard metal object might damage the grating on the PurePrecision Tape Scale.

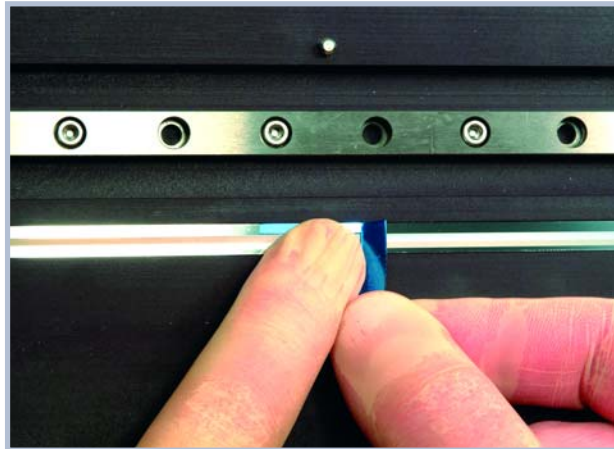

B8.2

(Applies only to Mercury II™ 5000 and 4000 models)

Repeat steps B8.0 and B8.1 for the left and right limit markers.

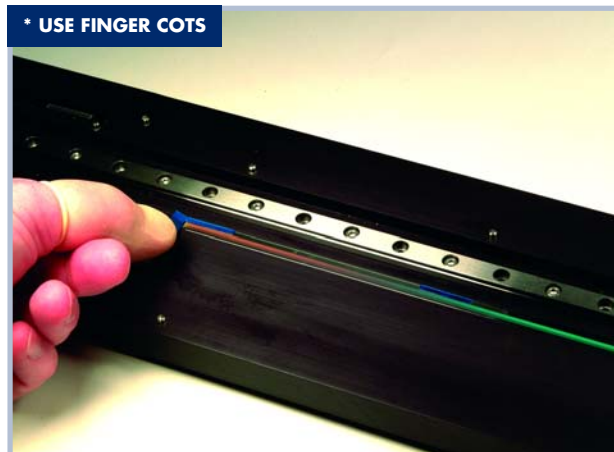

End Cap Installation

B9.0 Epoxy Setup

- Mix the two-part epoxy and place it in a syringe or on the end of a stick. Do not use a cotton swab to apply the epoxy.
- Put epoxy on the end of the scale. Make sure that the epoxy touches both the mounting surface and the scale across the width of the scale.



Only apply epoxy at the ends of the tape scale. Do not get any epoxy on the tape scale in the measuring area.

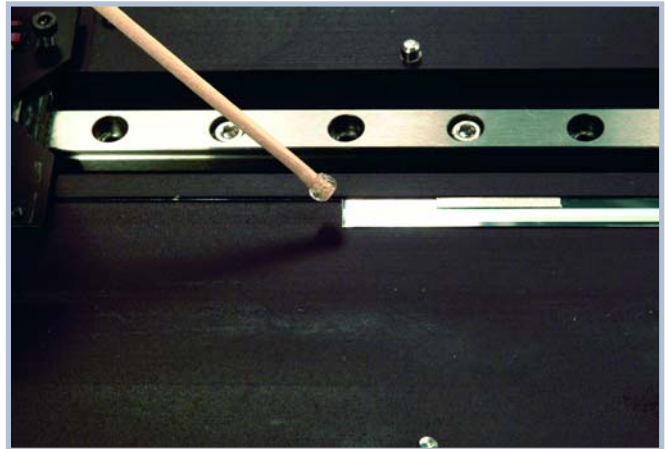

- Perform Step B9.1 immediately while the epoxy is still in a liquid state.

End Cap Installation

B9.1

Installing the End Caps on the Mounting Surface

- Remove the adhesive liner from end cap.
- Place the end cap on the top of the scale and epoxy so that the end of the scale is in the middle of the end cap.
- Press down lightly to ensure adhesion and let cure for 24 hours.



Final Cleaning, Inspection and Cure Time

B10.0

- Before using the encoder for servo control, clean the tape scale, index marker and limit markers using alcohol or acetone and a lint-free cotton cloth or swab. Finally, inspect the tape scale's surface for scratches, adhesive spots or smears in the measuring length.
- A cure time of 12 hours is required for the tape scale's pressure sensitive adhesive to achieve the best performance and reliability.

Reworking to Correct Mistakes

B11.0

Once installed, the tape scale, the index marker, and the limit markers cannot be moved or removed and reinstalled. Reworking will require removal and discarding of the old tape or markers, and installation of new ones.

If only the index or limit markers have to be replaced, the tape scale can remain in place and be reused so long as there is no damage to the tape scale's surface. Do not use a tool made of metal or other hard material to remove the markers. Clean the tape scale's surface completely of any adhesive residue before applying new markers.

Troubleshooting

F1.0

Problem

The Power/Calibration indicator will not come on.

Solution

- Make sure that the SmartPrecision™ II electronics' 15-pin D-sub connector is fully seated and connected.
- Confirm that +5 Volts DC is being applied to pin 12 on the SmartPrecision II electronics' 15-pin connector and that pin 11 is connected to ground.

Problem

Can't get the SmartPrecision II electronics' "Signal" LEDs better than red or yellow; or the green, " Proper Alignment" indicator doesn't stay illuminated over the full length of the scale.

Solution

- Verify that the sensor is mounted in the correct orientation with reference to the scale and scale mounting reference edge. Refer to the Interface Drawing.
- Verify that the sensor has been aligned to the scale and that the mounting screws are tight. Check the dimensions for the mechanical mounting holes (and clamps if any) to make sure that the sensor is correctly located over the scale in the Y and Z dimensions. Refer to the Interface Drawing.
- Check that the scale is firmly mounted and can't jiggle or move in any direction other than the axis of motion.
- Make sure that the scale is clean over its entire length or circumference.

Problem

The green Power/Calibration indicator LED or limit LEDs are flashing unexpectedly.

Solution

- Part of the normal setup procedure is to activate the SmartPrecision II Electronics' Calibration/Setup process by pressing the recessed button in the electronics module. The Power/Cal. LED or limit LEDs will begin to flash until the relevant setup process is complete. See the instructions beginning at section D1.5.

Problem

Can't Complete the Calibration/Setup process - the green Power/Calibration indicator doesn't stop flashing.

Solution

- Verify that the sensor is mounted in the correct orientation to the scale for the desired index mark. Refer to the Interface Drawing.
- Refer to section D1.7 to insure proper sensor alignment and index marker operation.

Cleaning Scales

F2.0 General Particle Removal

Blow off the contamination with nitrogen, clean air, or a similar gas.

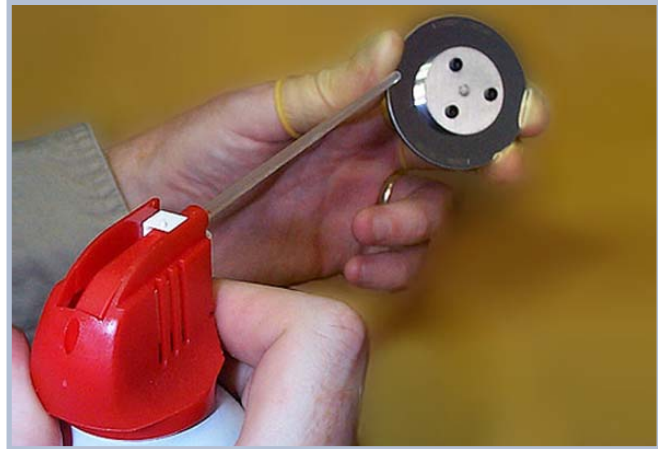
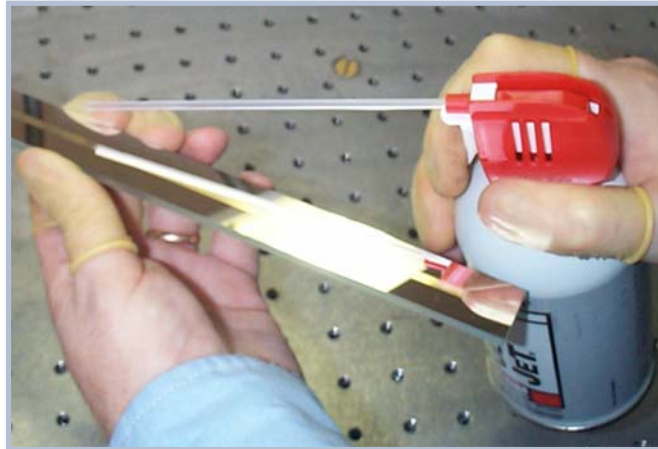

Cleaning Scales

F2.1

Contamination Removal

Use a lint-free cleanroom wipe or cotton swab dampened with isopropyl alcohol or acetone to wipe the surface clean. Handle the scale by the edges. Do not scrub the scale.

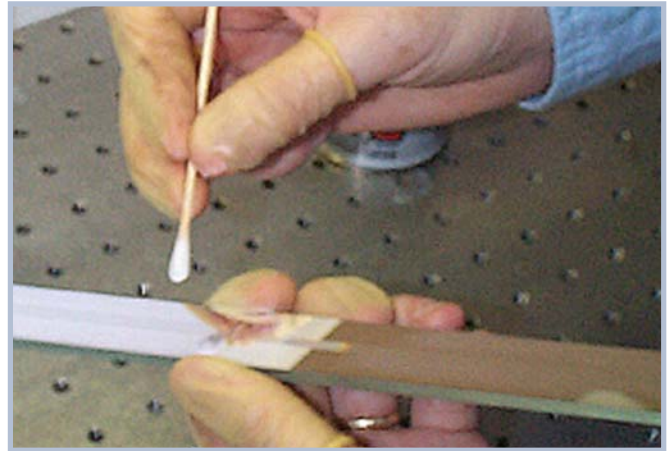

Contacting MicroE

GSI
TM

Precision Technologies

Semiconductor Systems

A World of Enabling Technologies

Bringing Your Advanced Manufacturing Applications to Life

To learn more about Mercury™ encoders, or other MicroE Systems products, visit: www.microesys.com.

To learn more about GSI Group, visit our corporate web site: www.gsig.com.

MicroE Systems is a world leader in optical encoder technology with offices in major industrial centers around the globe. As one of fourteen product brands that comprise GSI Group, we deliver enabling technology that brings advanced applications to life in the motion control, medical, semiconductor, electronics and industrial markets.

Headquarters

MicroE Systems
125 Middlesex Turnpike.
Bedford, MA 01730 USA
Tel : 781-266-5700
Fax: 781-266-5112

www.microesys.com

Email: info@microesys.com

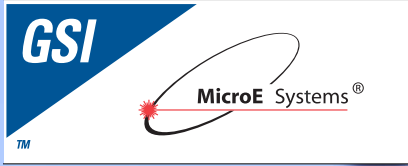

Mercury II™ Linear Glass Scales

Installation Manual and Reference Guide

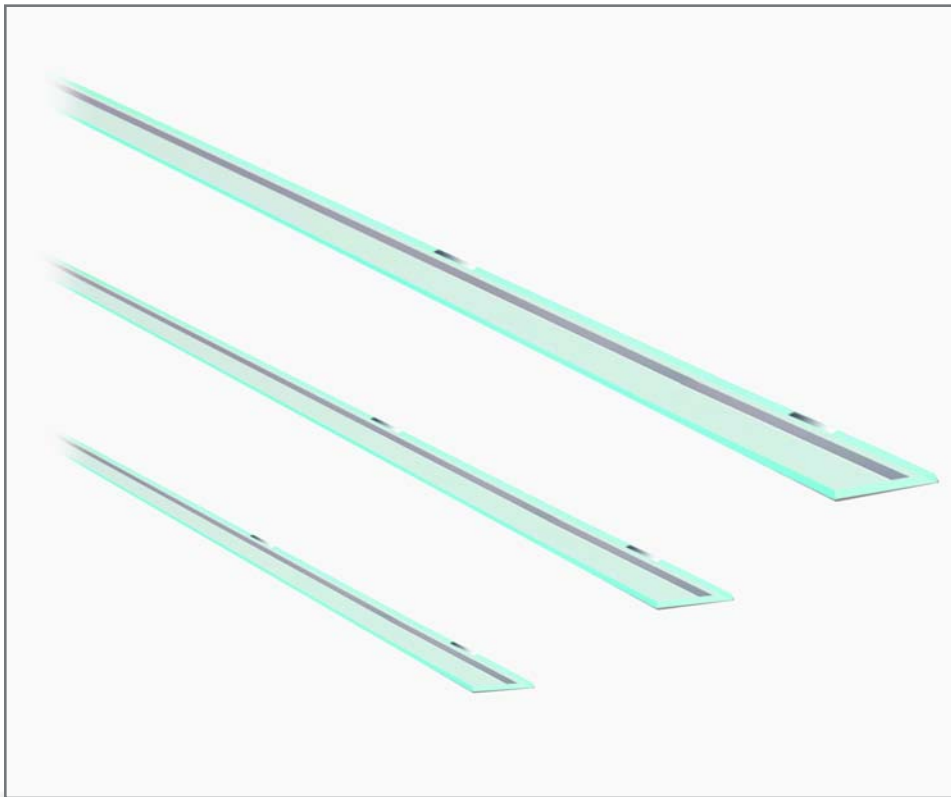

MicroE Systems - World Headquarters: 125 Middlesex Turnpike, Bedford, MA USA 01730-1409

IM-Mercury_II_Glass_Scale Rev E

www.microesys.com

info@microesys.com

T. 781-266-5700

F. 781-266-5112

©2015 MicroE Systems

Introduction

MicroE Systems was founded to advance encoder technology to a level never before achieved. Our objective was to design encoder systems that would be small enough to fit into densely packed OEM equipment designs, affordable enough for cost-sensitive applications and easy enough to enable installation, setup and alignment by assemblers with little training. We are pleased to say that all of these goals have been realized with the introduction of the original Mercury™ family of encoder systems. Now, the Mercury II series offers all of that plus improved performance, ease of use and versatility.

Precautions



- 1 Follow standard ESD precautions. Turn power off before connecting the sensor. Do not touch the electrical pins without static protection such as a grounded wrist strap.
- 2 Do not touch the glass scale unless you are wearing talc-free gloves or finger cots. Please read this installation manual for full instructions.

LASER SAFETY INFORMATION: Mercury & ChipEncoder

This product is sold solely for use as a component (or replacement) in an electronic product; therefore it is not required to, and does not comply with, 21 CFR 1040.10 and 1040.11 which pertain to complete laser products. The manufacturer of the complete system-level electronic product is responsible for complying with 21 CFR 1040.10 and 1040.11 and for providing the user with all necessary safety warnings and information.

MicroE encoders contain an infrared laser diode or diodes. Emitted invisible laser radiation levels have been measured to be within the CDRH Class 1 range, which is not considered hazardous; however, to minimize exposure to the diverging beam, the encoder sensor should be installed in its operational configuration in close proximity to the encoder scale before power is applied.



- Invisible laser radiation; wavelength: 850 nm
- Max power 2.4 mW CW (4.8 mW CW for Mercury II™)
- CAUTION – The use of optical instruments with this product will increase eye hazard. DO NOT VIEW DIRECTLY WITH OPTICAL INSTRUMENTS (MICROSCOPES, EYE LOUPES OR MAGNIFIERS).
- All maintenance procedures such as cleaning must be performed with the MicroE encoder turned off.
- Do not insert any reflective surface into the beam path when the encoder is powered.
- Do not attempt to service the MicroE encoder.

Patents

Covered by the following patents: US 5,991,249; EP 895,239; JP 3,025,237; US 6,897,435; and EP 1,451,933. Additional patents and patents pending may apply.

 Mercury II models are CE and RoHS compliant.

System Overview

Encoder with Linear Glass Scale

A1.0

Items Required for Mercury II™ Encoder Installation Using Glass Scales

In addition to the items in the System Views, you will need the following items available:

- Index and Limit Marker sheet
- Finger Cots or talc-free gloves
- Acetone or isopropyl alcohol
- Lint-free cotton cloths or wipes
- Two-part epoxy (Tra-Con Tra-Bond 2116)
- Stick and disposable surface for stirring epoxy
- Silicone adhesive (RTV)
- Tra-Bond 2116 and RTV are not recommended for vacuum applications

Mounting Surface Preparation

B1.0

Inspect the mounting surface for any machining irregularities. MicroE Systems recommends a surface finish of better than 3.2 micrometers Ra.

B1.1

MicroE Systems recommends a mounting surface flatness of 0.0001 inch/inch.

B1.2

Thoroughly clean the scale mounting surface and reference edge using a cotton swab or lint-free cloth dampened with isopropyl alcohol or acetone.

Remove all dust and particles.

Mounting Surface Preparation

Mounting Linear Glass Scales

NOTE:

Before beginning the mounting procedure, use talc-free gloves or finger cots to handle the scales.

B2.0

MicroE Systems' linear scales should be permanently affixed to the mounting surface, using epoxy and silicone adhesive.

"Benching" the scale to the system means aligning the scale by means of benching pins.

Two benching pins are recommended on the long side of the scale and one at the end as shown.

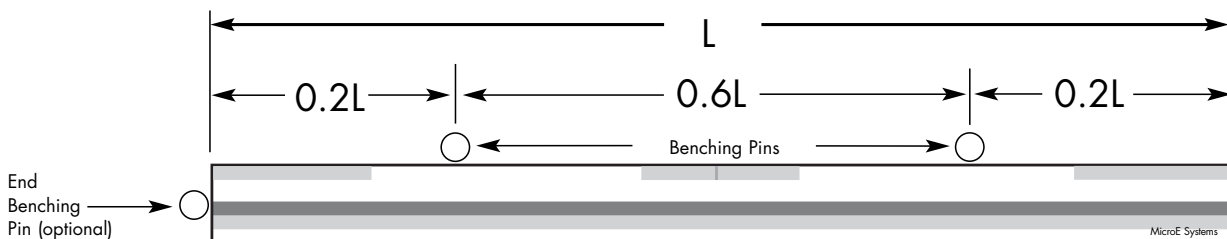

B2.1

Position the benching pins inward from either end of the scale. 20% of the overall scale length is the recommended location from the edge.

B2.2

Be sure the benching pins do not exceed the height of the scale to prevent mechanical interference with the sensor or sensor mount.

Installation of Linear Glass Scales

Mounting Linear Glass Scales

C1.0

Make sure that the mounting surface is dry and clean.

C1.1

Align the scale by placing the edges against the benching pins.

C1.2

Optionally, scale clamps may be used to secure the scale while the adhesive cures. (PN:160-00002)

C1.3

Apply a hard epoxy, such as Tra-Con's Tra-Bond 2116, at one point on the scale. If no end benching pin is used, epoxy at the index mark is suggested. If an end benching pin is used, epoxy at the end of the scale where the pin is located is suggested. Then apply 100% Silicone RTV adhesive around the edges of the scale.

C1.4

Do not allow epoxy to seep under the scale as this will affect scale flatness and therefore, encoder accuracy.

C1.5

After adhesive curing, remove the scale mounting clamps.

NOTE:

Tra-Bond 2116 and RTV not recommended for vacuum applications.

Index and Limit Marker Installation

Linear Glass Scales

Put on finger cots before starting the index and limit markers installation.

C2.0

NOTE:

Remove the Limit and Index Markers from the perforated sheet slowly to avoid premature detachment of the markers from the handles.

Removing the Index Marker from the Perforated Sheet

Begin by holding the Limit and Index Marker sheet so that blue protective film is on top (facing you).

Starting from the handle, remove the index marker from the perforated sheet by pressing gently from behind with your finger as shown.

It should pull away from the transparent adhesive liner. Holding only the handle, slowly pull the index marker from the perforated sheet.

NOTE:

Be sure to hold the index and limit markers by the handle only. The adhesive on the handle can be touched, however be careful not to touch the adhesive on the areas of the markers that will be applied to the scale.

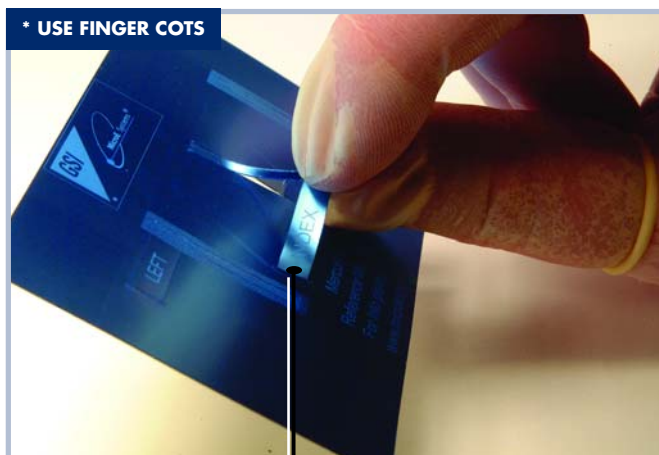
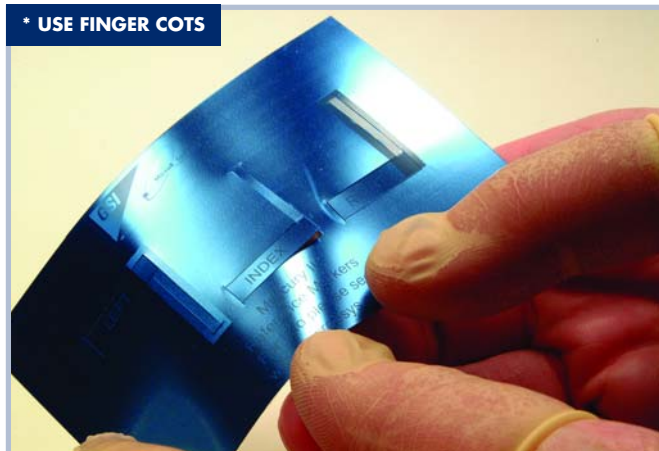
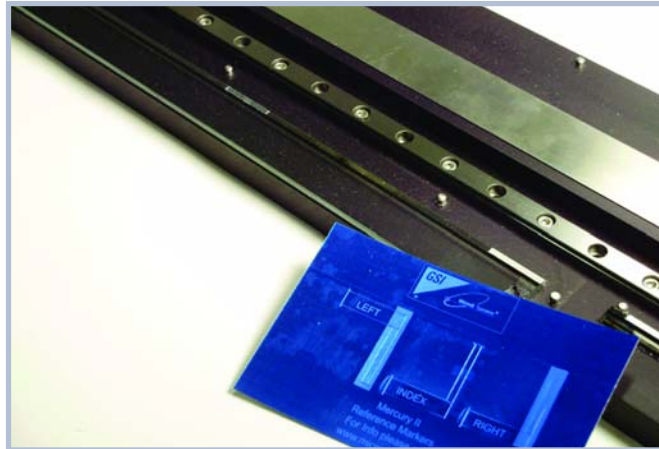

Index being removed from the perforated sheet by holding it by its handle.

Index and Limit Marker Installation

Linear Glass Scales

C2.1

Attaching the Index Marker to the Glass Scale

Place the top edge of the marker at the top edge of the scale so that the marker will not overhang the edge but will remain inside the chrome reference track. See interface drawings. ° degree angle as shown in the photo.

Press the marker onto the glass scale with your finger to ensure full adhesion.

Note: Marker adhesive reaches it's full cure after 72 hours. Avoid vigorous wiping or cleaning before this to prevent shifting or peeling up the marker. Light wiping pressure is okay.



Index and Limit Marker Installation

Linear Glass Scales

C2.2

Press your finger on the marker close to the edge of the handle. Then, with your other hand, pull up on the handle to detach it from the marker. The handle will break away from the marker.

Carefully remove the blue protective film from the marker surface.



TIP:

Use fingernails or plastic tweezers to remove blue protective film, but do not use a hard metal object. Using a hard metal object might damage the grating on the glass scale or the marker.



C2.3

(Applies only to Mercury II™ 5000 and 4000 models)

Repeat steps C2.0 and C2.1 for the left and right limit markers.

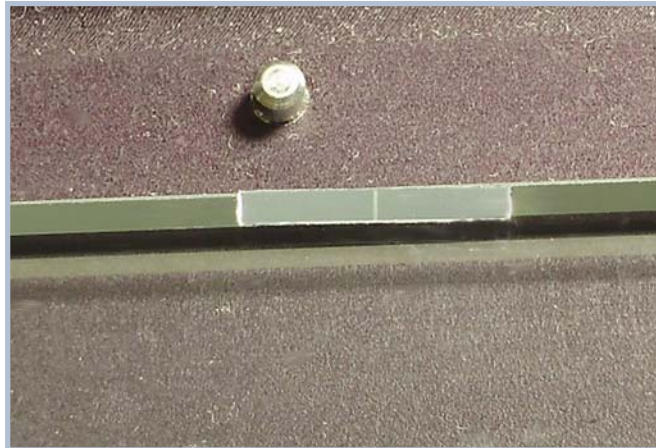

Cleaning Scales

D1.0

General Particle Removal

Blow off the contamination with nitrogen, clean air, or a similar gas.

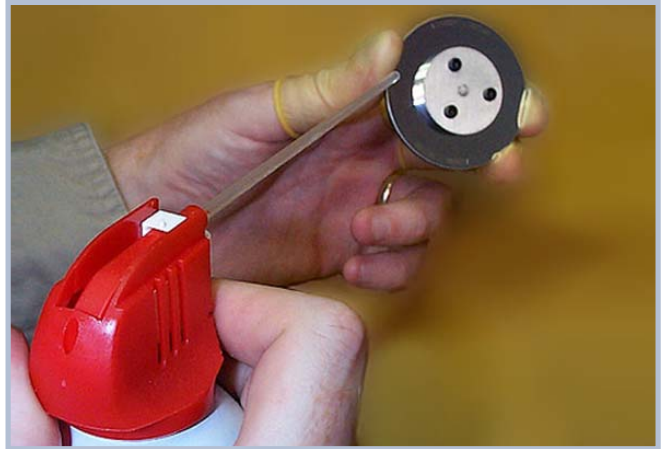
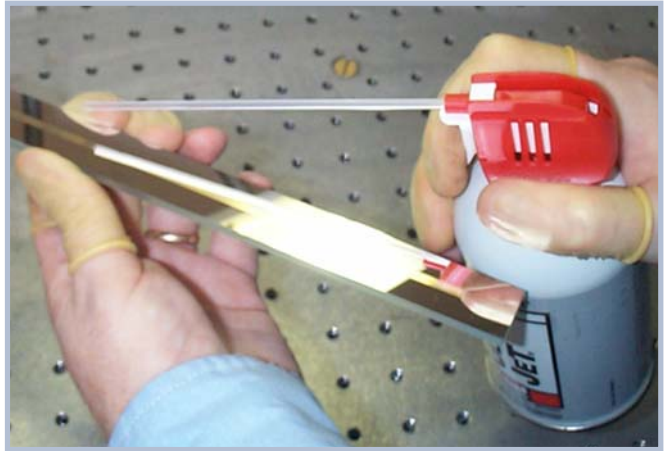

Cleaning Scales

D1.2

Contamination Removal

Use a lint-free cleanroom wipe or cotton swab dampened with isopropyl alcohol or acetone to wipe the surface clean. Handle the scale by the edges. Do not scrub the scale.

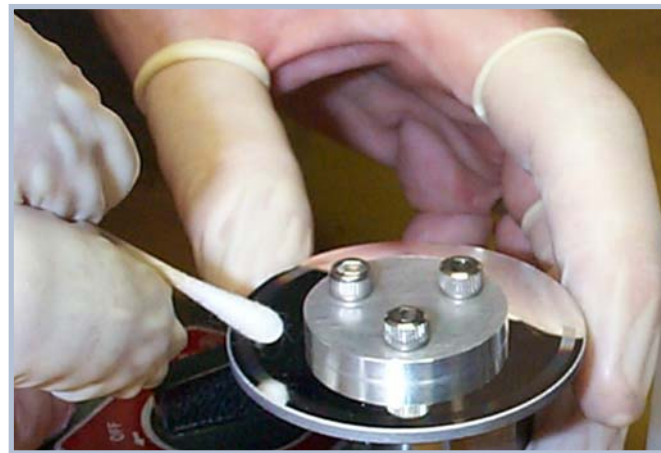
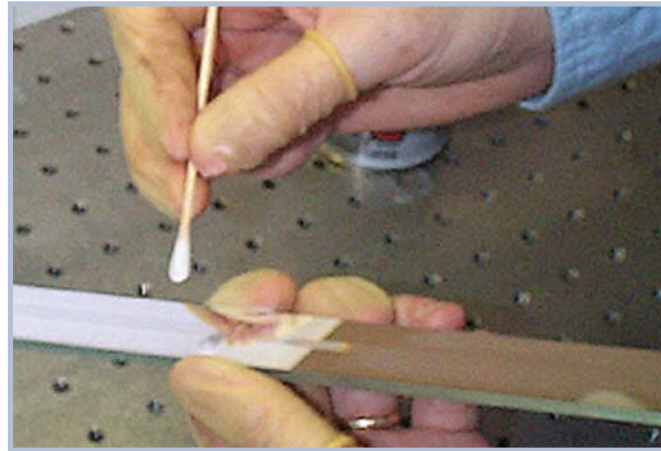

Contacting MicroE

GSI
TM

Precision Technologies

General Scanning Optical Scanners
MicroE Systems®
WESTWIND®
General Scanning Thermal Products
GSI Lasers®

Semiconductor Systems

General Optics®
WaferRepair™
WaferTrim™
WaferMark®
CircuitTrim™
SVS™

A World of Enabling Technologies

Bringing Your Advanced Manufacturing Applications to Life

To learn more about Mercury™ encoders, or other MicroE Systems products, visit: www.microesys.com.

To learn more about GSI Group, visit our corporate web site: www.gsig.com.

MicroE Systems is a world leader in optical encoder technology with offices in major industrial centers around the globe. As one of fourteen product brands that comprise GSI Group, we deliver enabling technology that brings advanced applications to life in the motion control, medical, semiconductor, electronics and industrial markets.

Headquarters

MicroE Systems
125 Middlesex Turnpike.
Bedford, MA 01730 USA
Tel : 781-266-5700
Fax: 781-266-5112

www.microesys.com

Email: info@microesys.com